



# Installation Manual



Building a better future.

[superformicf.com](http://superformicf.com)

# We are **building a better future.**

SuperForm Products produces high-quality and sustainable **Insulated Concrete Forms** that bring our customers confidence and peace of mind by providing them efficient and reliable products with the ability to withstand some of the most extreme elements mother nature has to offer. We hold ourselves accountable to the SuperForm standard through our dedication to our product and our passion for quality, sustainability, and continuous improvement.

SuperForm ICF is intended to replace conventionally poured concrete foundation walls in residential and commercial construction. The rigid EPS provides both the form for the retention of wet concrete and thermal insulation for the exterior & interior walls. The EPS also provides superior sound barrier insulation for interior party walls. The plastic ties in the blocks (which are slightly recessed to prevent thermal bridging) are a threefold unit. First, they provide the “tie” member of the forms that holds the two panels of EPS the correct distance apart while the concrete is being poured. Secondly, they allow for proper placement of reinforcing bar by the way of 3 or 4 slotted pockets into which rebar is snapped. Thirdly, the 'T' shaped portion at each end of the tie is the member to which inside and outside finishes are attached. Thus, the Superform wall system accomplishes forming, framing and insulating in one step, providing a finished wall far superior to any other building method.

## Our Story

**In 1998 They made their dream a reality and SuperForm was born.**

Our father and uncle, two journeymen carpenters that swung the hammer for a living, recognized an opportunity: ICF was better than traditional wood frame construction in that it was rot proof, disaster resilient, sound dampening, energy efficient, and fire resistant.

**ICF was the way of the future.**



## Version 3

### Contents

Introduction .....	4-16		
Tools .....	17		
Materials .....	18		
Estimating .....	19		
Job Site Preparation .....	20		
Layout and Excavation .....	21		
Footings.....	22-24		
Wall Layout .....	25		
Staging Material .....	26		
SuperForm ICF - First Row .....	27		
SuperForm ICF - 2nd Row .....	28		
Joints / Seams.....	29		
Filler Block .....	30-32		
Reinforcing Steel / Bar .....	33-35		
Continuing Courses .....	36-37		
ICF Bracing / Scaffolding .....	38-40		
Window and Door Bucks .....	41-43		
T Walls .....	44		
3" Height Adjuster .....	44		
Gable Walls .....	45		
Top Row ICF .....	46-47		
Additional Support .....	48-51		
Wall Penetrations .....	52		
		Vertical Cold Joints .....	53
		Floor Connections .....	54-55
		Prepour Inspection.....	56
		Concrete Pour.....	57-58
		Post Pour Concrete Checklist .....	59
		Continuing on with ICF / Next Level .....	60-61
		Waterproofing / Dampproofing.....	62
		Installing Soprema .....	63
		Backfilling .....	64
		Brick / Stone .....	65
		Parging .....	66
		Electrical Installation .....	67
		Plumbing Installation .....	68
		Interior Finishes .....	69
		Exterior Finishes .....	70



**Scan to watch  
the SuperForm ICF  
Video Installation Series**



**Scan to download  
the SuperForm ICF  
Rebar Charts**



**Scan to visit  
our website  
[superformicf.com](http://superformicf.com)**

### DISCLAIMER

The information contained in this manual is for instructional purposes only. Superform Products Ltd. is not liable for any personal injury, loss of profit or other commercial damage resulting from the use of this guide. It is the full responsibility of the user to follow local safety codes and building codes.

# What's the Outcome?

The outcome of this manual is for you and your team to have an efficient, hassle free experience installing SuperForm ICF. We understand there are numerous personal preferences in the way ICF can be stacked and the following content is our recommendations. At SuperForm one of our values is quality and ultimately straight, square, plumb and level SuperForm walls is the desired result.

**SuperForm ICF is installed differently than other blocks. Following this manual is important for maximizing efficiency.**



# A Complete Package

SuperForm Products offers you the Complete Package: A Premium Wall System, your rigid insulation, and best in class accessories enhancing your SuperForm Building Experience. Get your full Insulated package on one truck from one vender, maximizing every load, order and project. 100% of SuperForm ICF components are manufactured in house in Canada and USA meeting all international building codes.

SuperForm ICF gives you confidence that your investment will stand the test of time by completing all major building steps into one simple process, saving significant time and resources

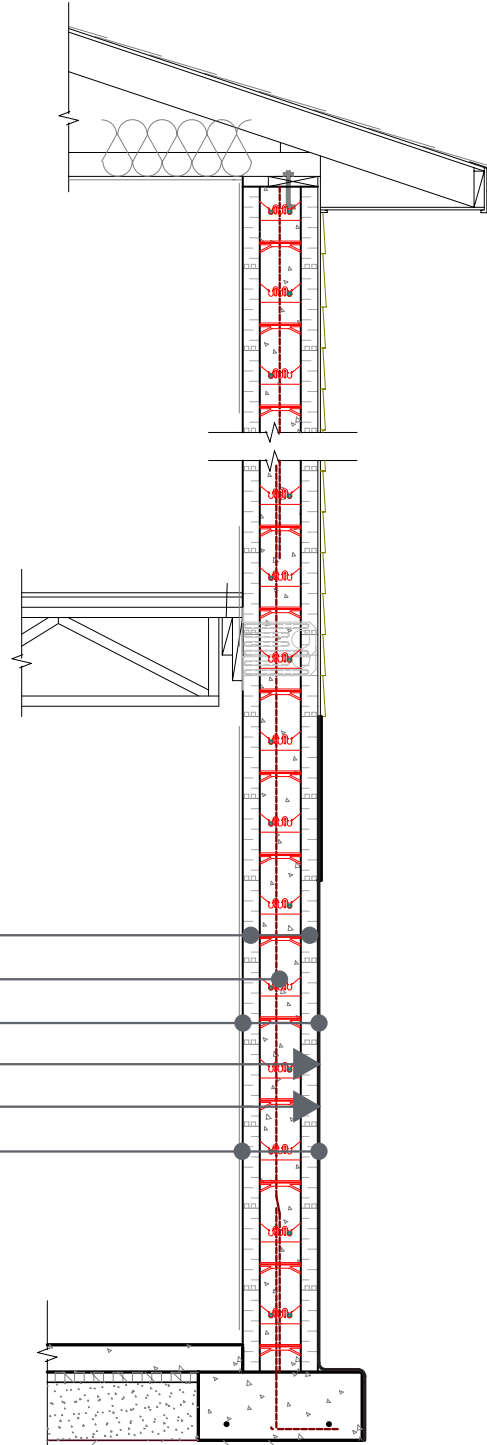

## 6 Building Steps in 1

- ▶ Forming System ●
- ▶ Wall Structure (rebar & concrete) ●
- ▶ Continuous Insulation ●
- ▶ Air Barrier ●
- ▶ Vapour Barrier ●
- ▶ Interior & exterior attachment points ●

## ICF Building Types

- ▶ Schools
- ▶ Churches
- ▶ Root Cellars
- ▶ Agricultural
- ▶ Commercial
- ▶ Swimming Pools
- ▶ Office buildings
- ▶ Multistory
- ▶ Retaining Walls
- ▶ Industrial
- ▶ Houses
- ▶ Dog Houses
- ▶ Green Houses

# SuperForm ICF Codes and Standards

Whenever applying code to ICFs the most ideal approach is to think of an ICF wall as a monolithic flat reinforced concrete wall with foam plastic insulation and attachment points applied to both sides of the concrete core.

## **Canadian Code Compliance - NBCC - National Building Code of Canada**

Above and below grade walls are covered for buildings not greater than 600 sq meters(6458 sq ft.) with a max floor to floor height of 3 meters and a building limit of 2 storeys above the basement foundation. Minimum concrete core for above grade walls is 140mm. See section 9.15.4.5 for below grade details See section 9.20.17 for above grade details

If your project falls outside of these parameters either you will need a stamp of a licensed engineer or prescriptive engineering tables from Superform with an engineered stamp.

**The standard governing ICF's in Canada is CAN/ULC-S717.1-12 "STANDARD FOR FLAT WALL INSULATED CONCRETE FORM (ICF) UNITS". Refer to CSA A23.3 "Design of Concrete Structures" for concrete structural design.**

## **USA code compliance - IRC Section R611**

Maximum building size - 60' in plan dimensions.  
Floor clear span limit - 32 ft  
Roof clear span limit - 40 ft.  
Maximum building height - 2 stories above grade or 35' in roof mean height.

Maximum wall height - 10 ft/story with concrete core thickness ranging from 4"-10"  
Maximum wind speed - 130 miles/hour exposure B, 110 miles/hour exposure C and a 100 miles per hour exposure C

Floor/ceiling dead loads - cannot exceed 10 pounds/ sq ft.  
Roof/ceiling deadloads - cannot exceed 15 pounds/ sq ft.  
Attic live loads- cannot exceed 20 pounds/sq ft.

Maximum Roof overhang - 2 ft beyond exterior wall  
Maximum dead load of overhang - 8 lbs/sq ft.

For applications falling within the parameters of the IRC Section R611, the stamp of a licensed engineer will not be required for code approval in jurisdictions that have adopted the International Residential Code, or for walls designed to PCA 100 or ACI 318.

For applications falling outside of these guidelines you will need the stamp of a licensed engineer or engineer stamped prescriptive drawings.

The standard governing ICF's in the USA is ASTM E2634, "Standard specification for flat wall insulating concrete systems" Refer to ACI 318 'Building code requirements for Structural Concrete' for the design of the concrete wall.

Superform uses QAI for third party testing to make sure we meet building code and quality control testing requirements.



# SuperForm Resources



Scan to view the  
SuperForm Resources

## Estimate Generator

The SuperForm Estimator will provide a detailed take off of the SuperForm materials you will need for your project. Be sure to refer to the install manual for guidance and reinforcement manual for rebar details.

## Training

Our Training Seminars provides attendees basic Superform ICF installation skills for building ICF structures. Whether you are an experienced ICF installer or a have never stacked a block in your life, this course is for you. It offers the best practices derived from years of experience.

## Training Videos

Our training videos offer intense value to ensure your get a quick question answered on the jobsite or to study them in detail giving you confidence when stacking ICF.

## Brochures

Our line of Brochures offers incredible detail to help you and your customer understand the benefits of the SuperForm Block, of ICF, ultimately helping you make your pitch to your client easily.

## Manuals

Our Manuals help you build your project easily, understand rebar specs, covering you every step of the way.

## Testing

Superform Products does intense testing on all its products, making sure its ready to stand the test of time. We are audited by a QAI holding us accountable to the highest of standards.

## Technical Support

SuperForm has experienced technical support available during regular business hours.

**877.627.3555 ext. 4**



# Energy Efficiency

The building industry is demanding tighter and more energy efficient buildings with effective R values of 40 and above. SuperForm ICF offers better energy solutions for any structure. Studies have proven that SuperForm ICF has 58% better R-value than conventional wall systems, resulting in energy savings of up to 60% per year. This is achieved by the thermal mass of the concrete, superior air tightness, and continuous insulation on both sides of the wall assembly reducing the size of heating and air conditioning equipment.



# Disaster Resilience/Fire Resistant

The strength of SuperForm ICF is derived from a solid concrete. In our forms, concrete is cured in a perfect environment; making it 30% stronger than regular conventional concrete walls. Our 12" high block gives Engineers and Builders more rebar options. This creates one of the strongest walls available today. SuperForm provides high impact resistance and withstands up to 400km/h (250 mph) winds ensuring your safety inside your building. SuperForm ICF delivers exceptional fire protection from extremely low flame spread and smoke development resulting in a 4 hour fire protection rating.



ICF home surviving a 250mph hurricane on Mexico Beach Florida



# Enhanced Owner Comfort and Satisfaction

- ▶ Drafts and cold spots in the home are eliminated in norther climates.
- ▶ Humidity is easily controlled in warm, moist climates.
- ▶ EPS foam and concrete do not off-gas unhealthy and allergy-aggravating emittances.
- ▶ No nutrient source exists in the ICF wall assembly for unhealthy mold growth.
- ▶ SuperForm ICF has a STC rating of 54.



# Design Flexibility

SuperForm ICFs are designed with maximum design freedom, with a 1" repeating cut lines. This allows you to match any plan on the jobsite and helps reduce waste whether it is a radius wall, gabel wall, or anything else you want to achieve.



# SuperForm ICF vs Conventional Concrete Basement

30' x 40' x 9' High Foundation Comparison				
	SuperForm ICF		Conventional Concrete Basement	
Footings	5.3 Metres	\$1,187.00		\$1,187.00
Bracing/ Form Rental	ICF Bracing	\$300.00	Form/Bracing/Ties	\$1,080.00
Labour Footings		\$759.00		\$759.00
Pump Footings		\$550.00		\$550.00
8" Concrete	25 metres \$224/metre			\$5,600.00
6" Concrete	20 metres \$224/metre	\$4,480.00		
Rebar	55 Bars @ \$5/Bar	\$275.00	20 Bars	\$100.00
SuperForm	332 ICF retail \$17.00	\$5,644.00		
2x6 Interior Framing				
			78 16' @ \$9.75	\$732.30
Insulation	R24		R22	\$672.00
Poly			2 Rolls	\$92.22
Accoustical Sealant and Tape				\$31.50
Damproofing	6 rolls @ \$160/roll	\$960.00	6 rolls @ \$160/roll	\$960.00
Labour Set up & Pour Concrete		\$6,250.00		\$6,250.00
Pump Truck		\$750.00		\$750.00
Labour to Strip/ Scrape Forms		Time Saved		\$1,900.00
Labour Frame 2x6 Walls		Time Saved		\$750.00
Labour Insulate and Poly Int Walls		Time Saved		\$780.00
Total		\$21,155.00		\$22,194.02

**SAVINGS UP FRONT \$1,039.02**  
 Concrete 30% stronger in ICF. Faster installation = more jobs  
 \*disclaimer this number based on multiple quotes from multiple locations.

# SuperForm ICF vs Wood Main Floor

Framing Portion					
	Details	Price	Head	Quantity	Totals
Materials	2x6x8' studs	\$14.11	House	200 pcs	\$2,822.00
	2x6x16' plates	\$30.22	House	36 pcs	\$1,087.92
	2x6x10' studs	\$16.82	Garage	100 pcs	\$1,682.00
	2x6x16' plates	\$30.22	Garage	15 pcs	\$453.30
	6mill Poly 10' x 100'	\$52.69/roll		3 rolls	\$158.07
	2lb Sprayfoam Insulation	\$3.75/sq.ft.		3176 sq.ft.	\$11,910.00
	11-7/8 LVL	\$10.00/foot		36 feet	\$360.00
	7/16 OSB	\$76.50/sheet		67 sheets	\$5,125.50
<b>Total Materials</b>					<b>\$23,598.79</b>
<b>Labour</b>	Labour to frame walls, sheet walls		\$9.00/LF 8' walls \$11.00/LF 10' walls		<b>\$2,792.00</b>
<b>Total</b>					<b>\$26,390.79</b>
ICF Portion					
	Details	Price	Quantity	Totals	
Materials	10 mill Rebar	\$7.10 /stick	195 pcs	\$1,384.50	
	ICF Cost	\$18/standard ICF	441 pcs	\$7,938.00	
		\$24.42/tee block	16 pcs	\$390.72	
	ICF Bracing Rental	\$500.00	1	\$500.00	
	Concrete 30MPA	\$232.00/m3	27 m3	\$6,264.00	
	Pump	\$185.00/hr + \$5.00/m	4 hours	\$875.00	
	Mudsill	\$27.47 / 2x6x16'	20	\$549.40	
	Anchor Bolts	\$1.60/bolt	100 pcs	\$160.00	
Window/ Door Bucks	\$180/buck	18	\$3,240.00		
<b>Total Materials</b>					<b>\$21,301.62</b>
<b>Labour</b>	4 men @ \$50/hour		108 hours		<b>\$5,400.00</b>
<b>Total</b>					<b>\$26,701.62</b>

Numbers calculated June 2021



# The SuperForm Block Family

---

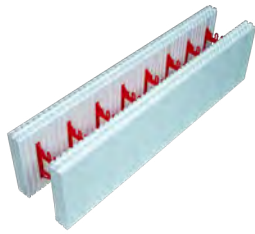

## **Straight Block**

Allows you to build straight walls with added durability and strength.

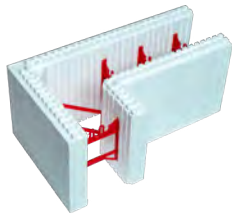

## **90 Degree Block**

Creates strong 90-degree corners with minimal time required and greater ease, accompanied by an extremely strong corner tie with multiple fastening areas for finishing.



## **45 Degree**

Creates strong 45-degree corners with minimal time required and greater ease, with multiple fastening areas for finishing.

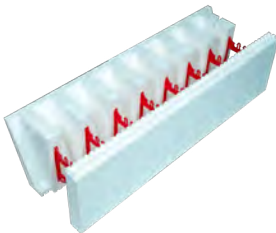

## **Brick Ledge**

Supports the installation of brick veneer on above-grade walls.

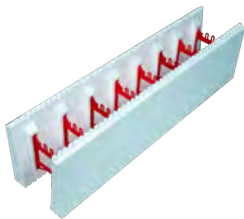

## **Top Block**

Provides maximum bearing surface at the top of your wall.

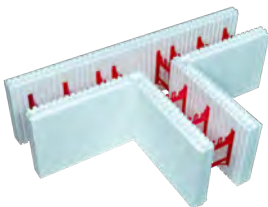

## **T Block**

Creates a T corner, eliminating the need for additional support or adjustments.



## **Height Adjuster**

Allows contractors to adjust the height of builds in small increments with minimal waste.

# The SuperForm Tie

SuperForm ICFs are designed with maximized strength from a 6" tie spacing.

---

## Virgin Tie Material

Our ties consist of virgin material, which gives a more consistent and higher tie strength. This makes your wall stronger and safer; giving you peace of mind knowing it will handle the pressure of concrete. Our tensile tests exceed strengths of over 850 lbs.

## Thickest Tie Flange

With the thickest flange on the market, our tie performs when fastening anything to it. You don't have to worry about stripping screws, making it the go to product for all builders. Our fastener withdrawal tests show up to double the strength of our competitors ties.

## 12" Tall Block

Due to the size of our block, our tie size is only 1' high, making it stronger due to more tie hold and less square footage than our competition (16-18" tall). This takes out all vertical and horizontal bulging along block joints, which gives you a flatter wall. This also gives you the option of a 12" rebar grid, making the wall stronger and giving engineers more options.

## Rebar Slots

Our rebar slots eliminate rebar tying, which leads to faster installation and less headaches.

## Concrete Flow Through

Our tie design allows for maximum concrete flow through.

## No Settling

Our ties run the full height of the block resulting in no settling during the concrete pour.

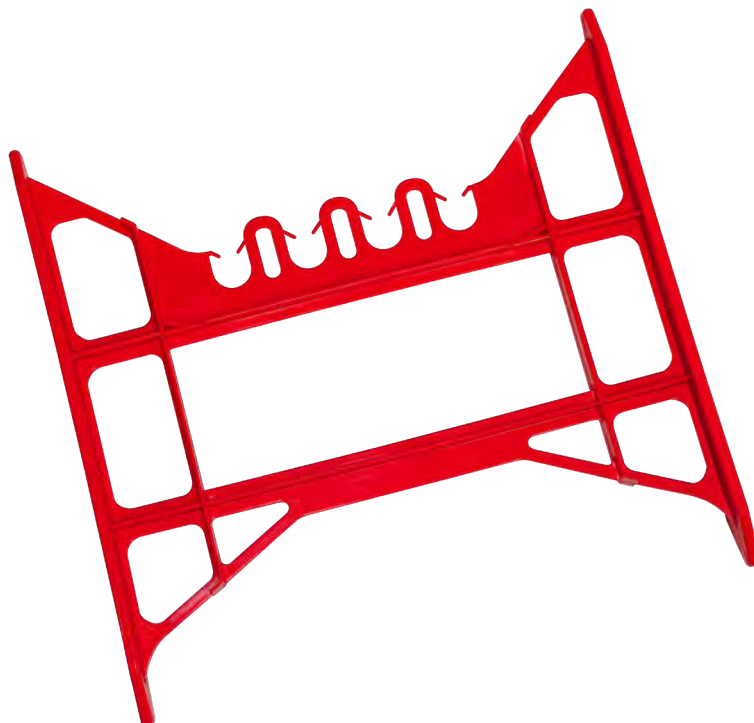

# The SuperForm Block

## Interlocking Knobs

Our unique square knob design offers 35% more surface friction fit than other systems on the market. The horizontal connection is so tight there is absolutely no vertical joint spreading.

## Tie

The SuperForm tie stands tall with outstanding performance when compared to other systems. Our thick red tie flange (7.25mm - 5/16th) every 6", are made of virgin polypropylene resulting in a higher more consistent tensile strength. You can have confidence that whatever you fasten to them will be secure. Our flow through design allows concrete to easily flow and bond to all EPS surfaces.

## Standard Sizing

Our standard sizing of 4' long x 1' high makes building and estimating extremely simple. Our light weight block is very easy to handle by yourself, making it easier to work in trenches or up on the scaffolding. The 12" block takes out all vertical bulging in the wall giving you a flatter wall and gives you more rebar options at 12" centers if needed.

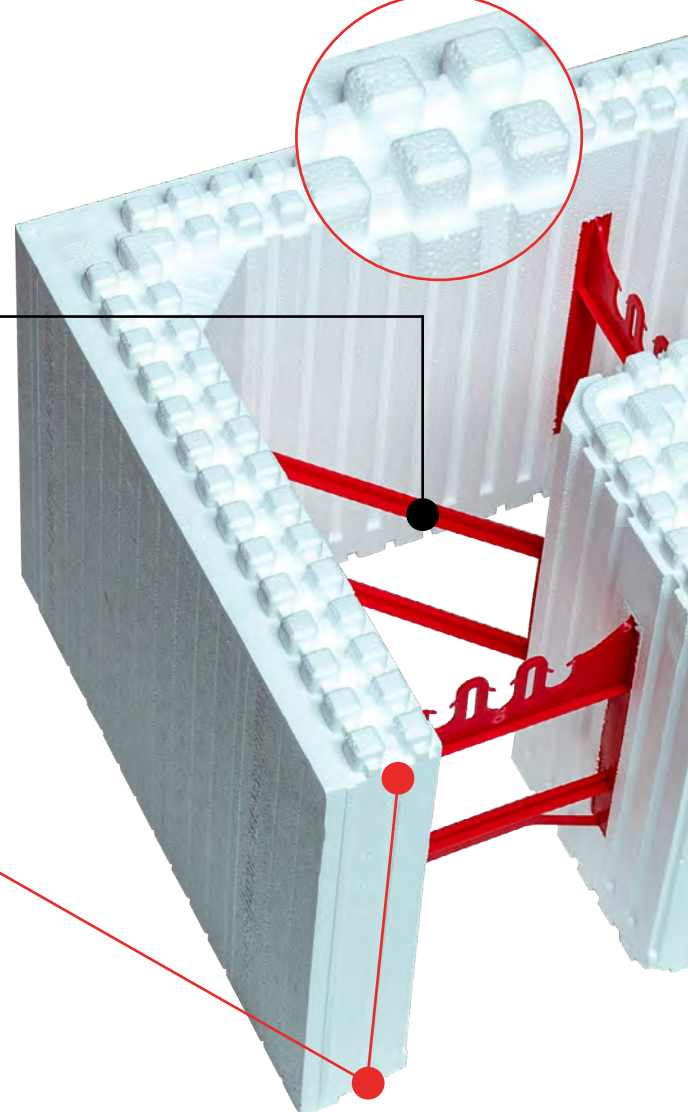

## Peace Of Mind During Install

All these features provide the installer peace of mind during the install and concrete pour. Due to the unmatched strength of SuperForm, there is no need for extra accessories. While other systems require zip ties, wire ties, glue/spray foam, form lock, kickers, or even applying plywood to every corner, SuperForm simplifies your installation without these extras. Because of our knob system, virgin tie material, and tie spacing, we create a simpler installation for builders; saving you significant time, effort, and money.

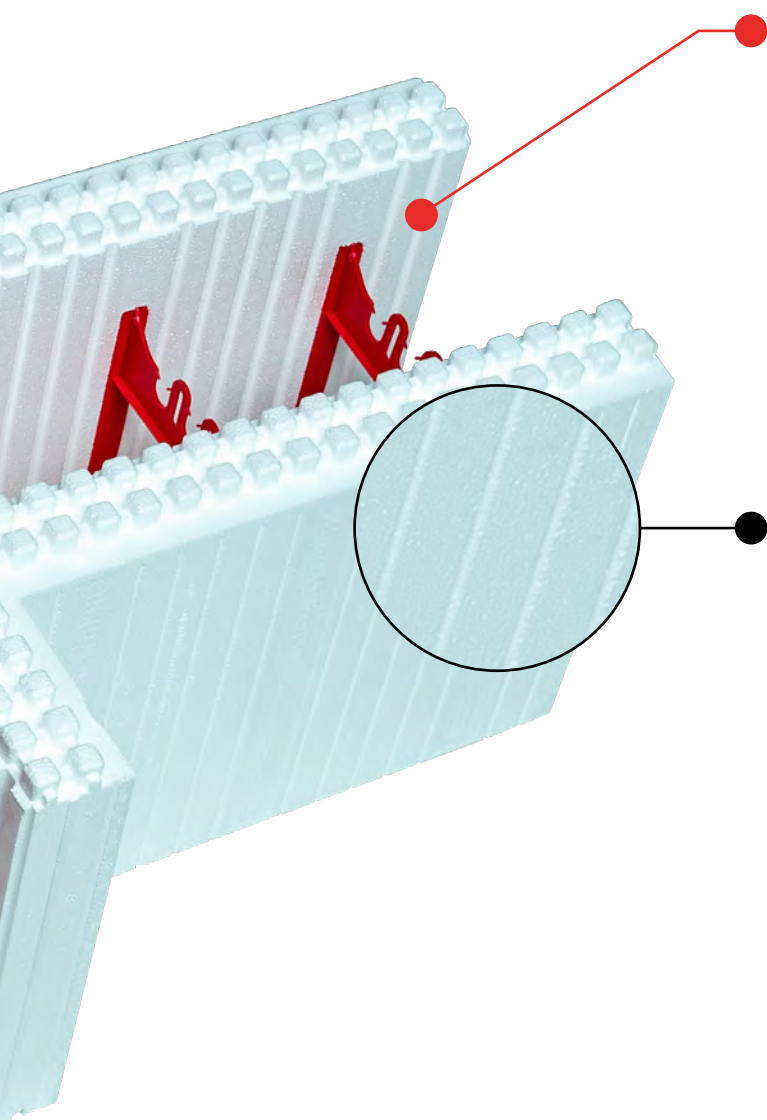

### Grooved Inside Panel

Our grooved inside panel is designed for better concrete adherence. Our panels lock the concrete and EPS together making a connection that will not separate. The built-in anti-lift technology, locking all blocks down by concrete pressure on it. This eliminates the need to tie or lock down each row, making your installation faster.

### Design Flexibility

SuperForm ICFs are designed with maximum design freedom with a 1" repeating cut lines. This allows you to match any plan on the jobsite and helps reduce waste.

### 6" Tie Spacing

Our 6" tie spacing provides up to 33% more tie per block resulting in one of the strongest blocks on the market. With only 4" of foam between ties and 2" of foam on the end of the block, this eliminates vertical or horizontal bulging along block planes and provides a flatter, straighter, and stronger wall. The 6" inch tie spacing also allows for more attachment points in your wall, giving you more options.

# SuperForm Insulation

Born from innovation - driven by technology. Your complete insulation package.



SuperForm MAX+ is one option available from SuperForm Products. It is a premium Neopor® graphite polystyrene (GPS) rigid foam insulation. MAX+ features all of the performance attributes of EPS+, complimented by the added benefits of a unique graphite cell structure. SuperForm MAX+ delivers one of the most efficient, cost effective, and sustainable insulation products available. Additionally, MAX+ meets CAN/ ULC S701 and ASTM C578 Standard Specification for Rigid, Cellular Polystyrene Thermal Insulation.



SuperForm MAX+ uses high-purity, graphite particles to create a reflective cell structure. This distinct cell structure reflects radiant heat as it travels through the insulation. Get maximum energy efficiency, stability and durability, and moisture management with MAX+. **Competes with XPS.**

#### Compressive Strength

Available in **10, 16, 20, 25, and 30 psi.**

#### Applications

Below Grade, Above Grade, Hydro Panel, EIFS+, Precast, Sip Panel, Frost Impact, SuperVoid, Geofoam, Roofing, Billets, Custom Cuts.



SuperForm EPS+ is another option available from SuperForm Products. It is a high-grade expanded polystyrene (EPS) rigid foam insulation. It provides a dependable insulation product that can be used for almost every type of building insulation application. A stable R-value and compressive strength provide an inexpensive, energy-efficient insulation solution available in a wide range of thicknesses. Additionally, EPS+ meets CAN/ULC S701 and ASTM C578 Standard Specification for Rigid, Cellular Polystyrene Thermal Insulation.



EPS+ is manufactured from expanded polystyrene resin using a pentane blowing agent. This process does not use the hydrofluorocarbons (HFCs) typically used to produce XPS. The result is a closed, air-filled cell structure that does not contain HFCs with a very low impact on the environment.

#### Compressive Strength

Available in **10, 16, 20, 25, 30, 40, and 60 psi.**

#### Applications

Below Grade, Above Grade, Hydro Panel, EIFS+, Precast, Sip Panel, Frost Impact, SuperVoid, Geofoam, Roofing, Billets, Custom Cuts.

**Check out our website for more information on MAX+ and EPS+**





Scan to watch the  
SuperForm ICF Video  
Rules, Tools & Materials

# Tools

This is a list of standard construction tools required on most Superform ICF job sites

---

1. Saws (powered or hand saws)
2. Rebar Cutter and Bender
3. Typical construction tools-tape measure, level, markers, stringlines, hammer, chalk lines, utility knife.
4. Laser level
5. Cordless drill set with cordless circular saw, reciprocating saw, and of course a cordless drill.
6. Ladders (step ladders)
7. Tie wire and pliers
8. Spray foam gun
9. Concrete rake, concrete vibrator and concrete trowel
10. Soprema roller



# Materials

This is a list of most construction materials found on a typical Superform ICF jobsite.

---

1. SuperForm ICF Blocks
2. Rebar
3. Footing Form Material
4. Window buck material (Foam Buck, 2"x12" treated lumber, or LVL)
5. ICF bracing and scaffold planks
6. SuperForm Dampproofing
7. Soprema Sopraseal
8. Sopraseal dimple board
9. Spray Foam
10. Rebar wire ties or wire
11. Anchor Bolts
12. Simpson Strong-tie ICFVL sets
13. Burmon truss connectors
14. 2" ICF screws
15. 3" ICF screws
16. 4" SuperForm tape
17. Fibre tape
18. Additional support material (7/16" OSB/ 1"x4")



# Estimating

There are a few different ways to estimate your Superform block, concrete and rebar.

## Option 1

Use Superforms Estimating spread sheet. This will give you takeoffs for rebar and concrete as well. Available on the website or request a version by email for you to keep on your desktop.

Job Features	1	2	3	+
Block Type	4"	4"	4"	
Wall Height				
Wall Length				
90 Inside Corners				
90 Outside Corners				
45 Corners				
T Blocks				
2' Height Adaptor	Linear Feet	Linear Feet	Linear Feet	

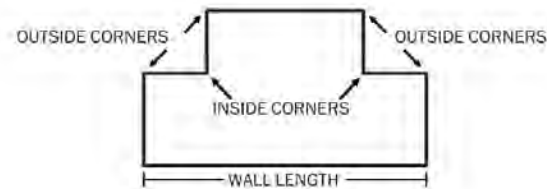

## Option 2

1. Calculate lineal feet of wall. (add up all the wall lengths) add 1' to the lineal footage for every inside corner.
2. Multiply the lineal feet by the height of the wall.
3. This will give you the wall square footage.
4. Subtract the square footage of openings (windows and doors) from the wall square footage.
5. Divide the square footage of the wall by 4 sq. ft. for the amount of blocks needed.
6. Multiply this number by 5 percent for a little extra waste around openings etc.
7. Multiply the number of courses by the number of corners in the floor plan. This will give you the amount of corner blocks needed.
8. Subtract the total number of corners from the total amount of standards to get your standard block count.
9. If a top block is required take the lineal footage of the wall and divide by 4. Subtract any corners. This will give you your top block count. Be sure to subtract your top blocks from the standard block count.

## Option 3

1. Calculate the lineal feet of the wall and figure out how many corners and standards will be needed on the first row.
2. Multiply by the number of rows required to get your total block count.
3. Take the opening sq. footage and divide it by 4 to figure out how many blocks to subtract for them.
4. Add 2% to the standards for waste around windows and doors.

## Estimating Time

An average house basement should take approximately 160 man hours to get footings in and SuperForm stacked, poured and cleaned up. As far as estimating time and man hours required, keep track of your crew's time. After a few jobs you will have an idea how many man hours go into an Superform ICF project. The more complicated jobs with lots of corners etc. will require more time so there will always be variables that affect man hours.

## Estimating Soprema Peel and Stick

Take your lineal footage of foundation and multiply it by your height of damp proofing required to get your total sq. ft. required. Do not forget to add approximately 1 foot to your height to account for the Soprema wrapping over and down the footing. Divide the square footage by 225 sq. ft. per roll to get the number of rolls required. Round up and order.



Scan to watch the  
SuperForm ICF Video  
Jobsite Preparation

# Job Site Preparation

First and foremost you and your crew's safety is the most important. Always follow all local building safety standards.

---

1. As with all projects jobsite preparation is critical to have a smooth, safe, and efficient run jobsite. Preplanning where excavated soil will be placed at the time of excavation will help as the project progresses. Have an idea where all the building materials will be kept if just in time delivery is not an option.



2. SuperForm ICF may be delivered on a 75' semi and enough room should be a priority to get a large truck and trailer into the site.



3. Concrete trucks and pump trucks will need access for pours as well. Be aware of overhead lines and any safety hazards that may be present.



# Layout and Excavation

The layout and excavation of a foundation will be the same as traditional construction.

---

1. Layout site in accordance with construction drawings and specifications. Make sure to locate all underground lines before you dig. Always follow local protocol before you dig.



2. Calculating the height of the basement or frostwall you will be building will determine the depth of the excavation. You will need to figure in the thickness of the footing as well. This calculation is very important for drainage and landscaping purposes. The right elevation will save the homeowner a lot of trouble.



3. Take into account soil conditions. In most cases footings need to be on virgin undisturbed soil if a excavation needs compaction contact your local engineer to discuss and possibly get a compaction test before proceeding if there is doubt or concern.





Scan to watch the  
SuperForm ICF Video  
Footings

# Footings

Footings are an important part of foundation construction. They are typically made of concrete with rebar reinforcement that has been poured into an excavated trench. The purpose of footings is to support the foundation and to transfer or distribute loads to prevent settling.

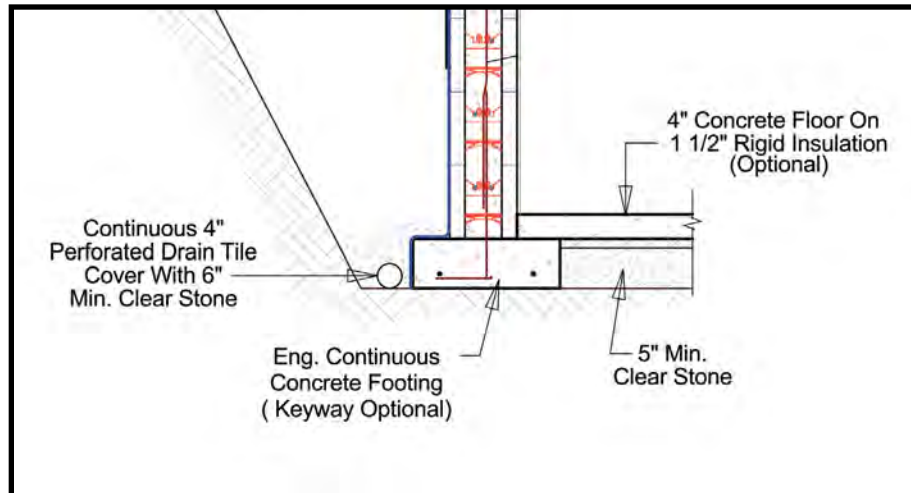

1. Rebar dowels are required to connect footings to ICF, typically at 4' on center and approximately 24" to 30" high for noncontact lap length. Always follow building local code and/or site engineering.



This picture shows the most common footing. However piles, bedrock and an engineered mono slab are all options.

# Footings

---

1. Install footing forms and rebar as required by plans and building code. Typically wood or aluminum forms with steel or wood stakes are used. Your footing forms need to be straight, level, and square.



2. Make sure to double check measurements as your footings will run 4"- 6" outside of your foundation wall for the SuperForm ICF to be centered on.

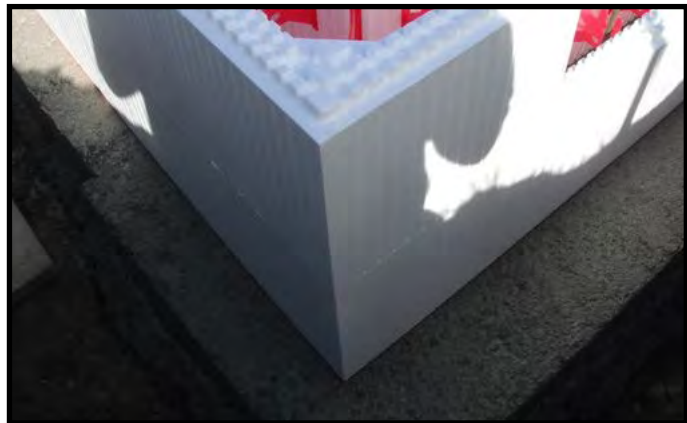

3. Use a laser level to get a perfect elevation.

**TIP!** Spending an extra 30 minutes leveling your footing will save you more time when you start stacking SuperForm. Footings need to be within an 1/8" of level. Screw or nail your forms to stakes at the desired height.

**VERY IMPORTANT** - your footing's need to be within an 1/8" of level.



# Footings

---

1. When pouring footings the easiest option is to use a concrete pump truck. A wheelbarrow or a concrete truck shoot are also options to fill the forms with concrete.



2. Place concrete into the formwork and use a screed (typically a straight 2x4) to level it off. Be sure to keep the screed tight to the forms so there are no humps in the concrete.
3. Block out any utility cavity's in the footing before the pour as needed and per code.
4. Wetset dowels to building specification and then let the concrete dry.

**Congratulations on getting the pour done!**



---

## Step Footings

5. Building on a slope or going from a 8' basement to a 4' garage wall may require a step footing. SuperForm is 12" tall and the typical step footing is 2'. This lets the 3rd row go directly over the step and continue on down the wall. Take into account local building code regulations.

12" increments

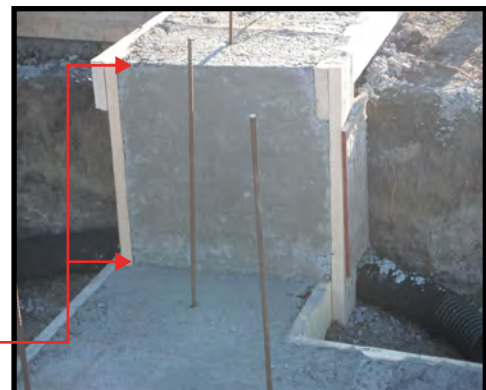



# Wall Layout

The layout of the wall is very important. It sets the standard for a square home.

1. A surveyor is a good option to get building lines transferred onto the footing perfectly. Or you can do it yourself by measuring lines onto footing according to plans. Layout accurate and precise 90 degree corners.
2. Start layout on a long wall or a wall that has strict setback requirements.



► The 3-4-5 method as an option to check square.

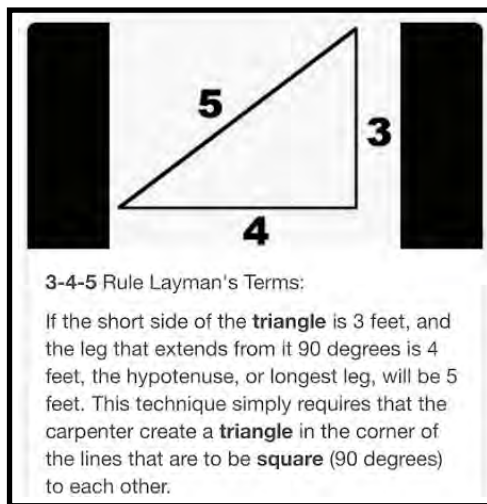

- Another option with a perfect rectangle or square is to check your diagonals. A and B will always be the exact same measurement.
3. Only apply chalk lines once you are confident that the measurements and layout is square.
4. Layout door openings and mark them on the footing so you know where they are when you start stacking blocks.

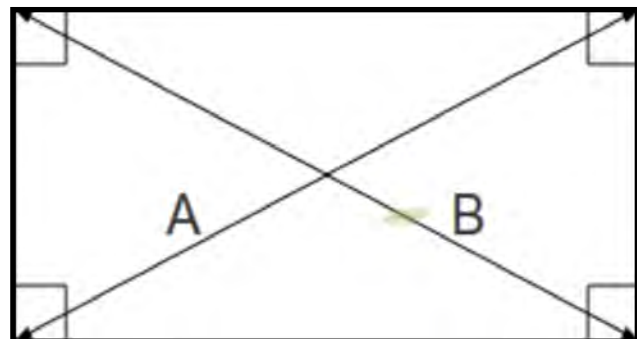

# Staging Material

---

1. Gravel can be brought into the hole using a bobcat or a rock slinger before you start setting blocks. Use care not to damage fresh concrete footings.



2. Fill the hole with SuperForm ICF, rebar and bracing and any tools you need. Use care when handling SuperForm, blocks shouldn't be thrown or dropped aggressively. If blocks are mistreated it could damage blocks and if this goes unnoticed it could cause an issue/blowout during the concrete pour.



3. **Keep the SuperForm ICF 6'- 7' back** to allow for diagonal bracing to be installed. Typically you will work from the inside of your project for jobsite efficiency instead of walking around the exterior.





Scan to watch the  
SuperForm ICF Video  
First & Second Row

# SuperForm ICF - First Row

In this chapter you will learn all about stacking the ICF. Let's get started, this is where the fun begins.

1. Always start laying ICF with 90 degree corner block.
2. Ensure there is an equal amount of left and right corners on the first row.
  - ▶ Take the time to lay the correct corners at each corner. This will save you time in the long run
  - ▶ Avoid cutting corner block unless absolutely necessary for short jogs
  - ▶ Kickers or foam are not required with SuperForm ICF do to our maximum bearing footprint sitting snug and stable on the footing if they are level.

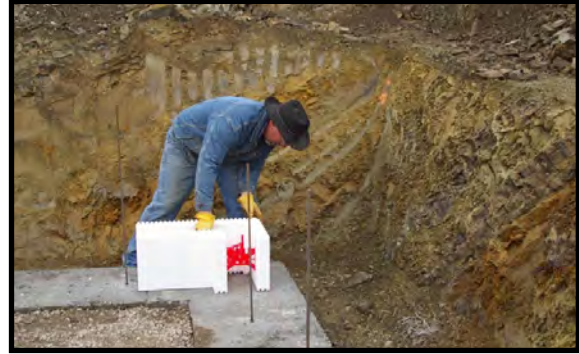

3. Proceed to lay standard blocks stacking clockwise on the chalk line, toward the middle of the wall.
4. At some point in the wall the blocks from either corner will meet and a block will need to be cut. This is called a filler block.
5. The section should be located at a door. If there is no door then it is located in the middle of the wall or at a window.
6. The filler block should not be cut until the second row is stacked. **See page 30**



- ▶ Due to the strength of SuperForm ICF Blocks and our interlocking systems, no clips, zip ties, foam adhesive, or formlock is needed until the top ICF row. This will save you significant time and money.



Scan to watch the  
Why SuperForm ICF Video



# SuperForm ICF - 2nd Row

1. Always start the second row at the corner again. Stack the opposite corner then the first row to maintain a 12" offset.
- ▶ Always alternate corner blocks(left or right) to maintain a 12" offset throughout the entire build.

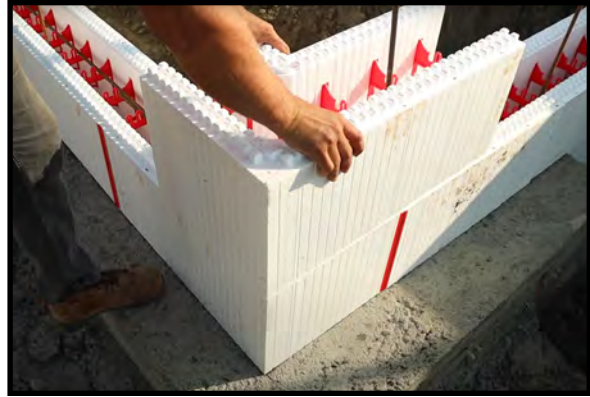

2. Proceed to lay the second row standards toward the middle of the wall.
3. When you've stacked the 2nd row up to the filler block area, a filler block will need to be cut. Stacking the 2nd row tightens all the loose standards up on the first row ensuring you get an accurate cut dimension for the filler block on the first row. **See page 30.**
4. Make sure blocks are firmly seated and compressed completely together.
5. Make sure there is a 12" offset locking the rows together.
- ▶ Remember horizontal bar may be required on the first row and needs to be set before the 2nd row of ICF is stacked. **See rebar requirements on page 33.**



- ▶ SuperForm ICF has 1" cutlines. For blocks to stack over each other the cutlines and ties need to line up.

**VERY IMPORTANT** – double check to make sure the ties line up.

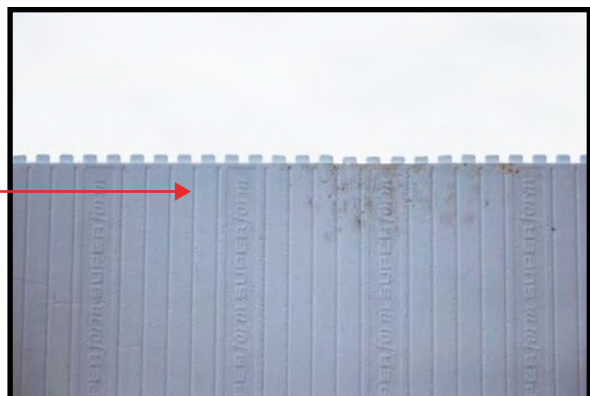

# Joints / Seams

---

## Stacked Joints

Creating a stacked seam means that the interlock is eliminated and the block will not overlap over the seam all the way from footing to top of wall. When cutting blocks save any pieces that are bigger than 6" for use anywhere else in the wall. All stacked seams will need to be supported with additional support (2x6 for stability if possible) on every row of ICF on both sides of the wall.

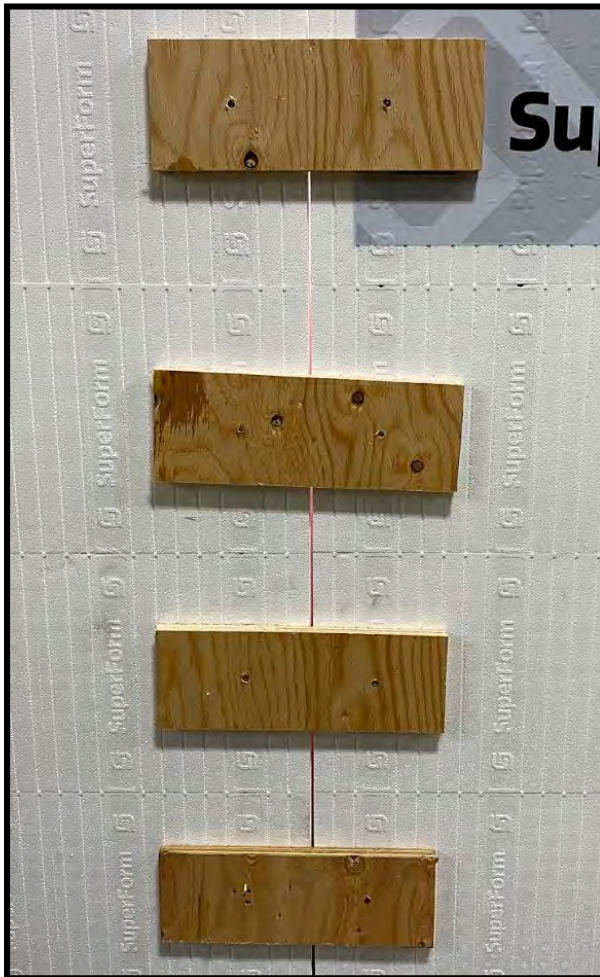

# Filler Block

---

1. At some point in the wall the blocks from either corner will meet and you will need to cut filler blocks to complete the 1st and 2nd row.
2. The section should be located at a door. If there is no door then it is located middle of the wall or at a window.



3. Before cutting this piece you need to check the follow to make sure you'll get an accurate cut dimension.
  - ▶ Both corners are on the chalk line.
  - ▶ Be sure the second row is stacked up to the filler block to tighten up all joints.
  - ▶ The standards are on the chalk making a straight wall.



**TIP! 4.** Write the measurement of the filler block on the first and second row to future reference and easy figuring or use the bar measurement option. See next page.



# Filler Block

## Bar Measurement

- ▶ 2 bars of foam
- ▶ 4 ties
- ▶ 1 bar of foam

Refer to this as a **2 - 4 - 1**

This is a quick and accurate measurement option.

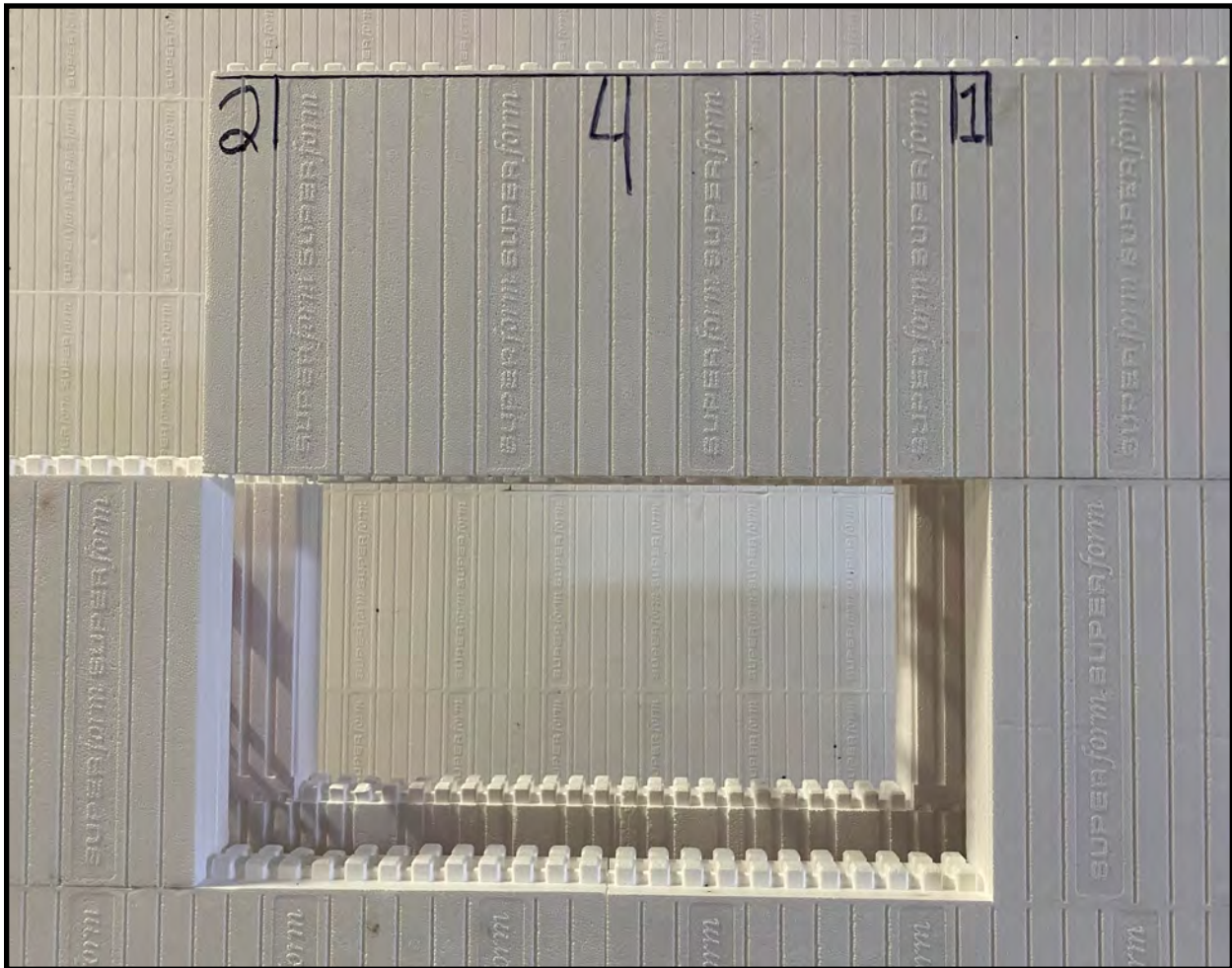

# Filler Block

---

## Angle of Block

When cutting filler blocks, it is important that your cut is 90 degrees. If it is over 90 degrees your filler block will start to push your walls out of level, causing you stress and significant problems as you continue. All blocks should always be cut at 90 degrees so the cutoff piece is usable and you don't have to recut when you use the leftover piece.



90 degrees



Less than 90 degrees



Over 90 degrees

- 
1. Always keep a marker handy, when you are stacking blocks. When you stack a block that will need additional support, mark a line over the joint. Lines indicate the need for additional support so it will not be missed when attaching additional support.

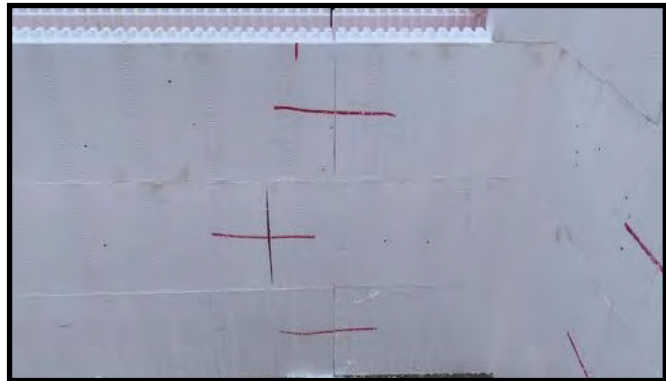

- 
2. After the third course is done check the for dips or humps in the walls incase the footing wasn't quite level and shim or cut blocks to ensure the ICF blocks are level. Shiming will be easier than cutting. The joints of the blocks should be snug all the way from top to bottom. If there are gaps the blocks are out of level.





# Reinforcing Steel / Bar



Scan to watch the SuperForm ICF Video Reinforcing Bar

- ▶ Rebar (short for reinforcing bar), known when massed as reinforcing steel or reinforcement steel, is a steel bar or mesh of steel wires used as a tension device in reinforced concrete and reinforced masonry structures to strengthen and aid the concrete under tension. Concrete is strong under compression, but has weak tensile strength. Rebar significantly increases the tensile strength of the structure. Rebar's surface is often "deformed" with ribs, lugs or indentations to promote a better bond with the concrete and reduce the risk of slippage.
- ▶ Major building codes around North America (NBCC, IBC and IRC) recognise Insulated concrete forms as a method of concrete wall construction. ICF is simply a concrete wall encased in EPS foam with embedded plastic attachment points. The engineering design and structure are all reinforced concrete walls.
- ▶ Always follow the engineering spec for rebar size and placement as per specifications and/or local building code. Typical rebar sizes are 10m ( $\frac{1}{2}$ " ) 15m ( $\frac{5}{8}$ " ) or #4 and #5.

- ▶ Lap length of the rebar is typically 40 times bar diameter in Canada. 10m or number 4 bar = 20 inch lap length. And 60 times the bar diameter in the USA. Number 4 bar= 30" overlapp. The bars do not need to be tied together because the rebar saddles hold them securely in place. Corner bars can be pre bent for efficiency.

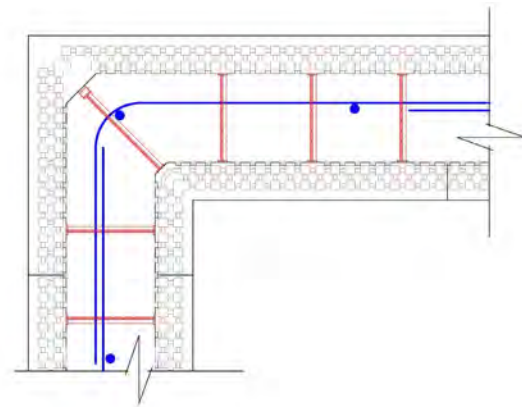

- ▶ In applications where it is necessary to have 2 rows of reinforcing bar per course of SuperForm, the 2 slots used would always have 1 or 2 empty slots between them typically. This will ensure that enough space is allowed around each bar for the unobstructed flow of concrete with aggregates up to  $\frac{3}{4}$ " in width. The rebar slots will accept up to  $\frac{5}{8}$ " bar, and  $\frac{3}{4}$ " in the 8" forms. Care should be taken to ensure that the reinforcing bars are reasonably straight. Bars that are bent or deformed can prove to be troublesome in that they cause the wall to assume irregularity. Also, when bending rebar for corners or other angles, a rebar bender/shear is preferred. This tool will help in maintaining true, square corners and angles.

## Non-contact Lap Splice

The reinforcing bars are allowed to be spaced at a distance of one fifth ( $\frac{1}{5}$ ) of the lapped length to a maximum of 150 mm or 6 inches.

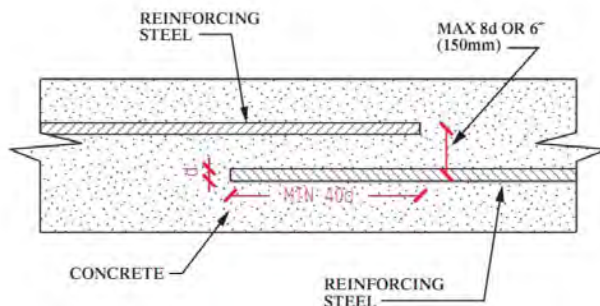

## Contact Lap Splice

The lapped reinforcing bars MUST be in contact with each other and secured together.

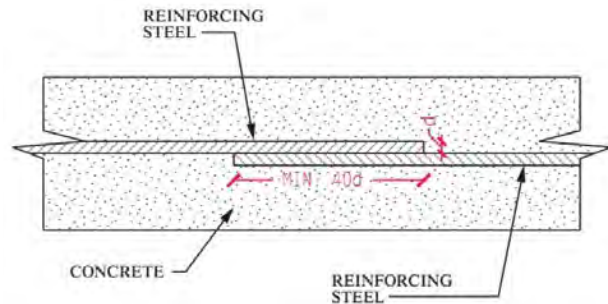

# Reinforcing Steel / Bar

## Horizontal Rebar

1. Rebar snaps nicely into the rebar chairs. These chairs are placed to allow proper coverage between the rebar and the EPS foam.
2. Offset your horizontal rebar by staggering every row of bar will hold the vertical bars in place. Because of this vertical bars do not need to be tied at the bottom.
3. Insure horizontal bar does not touch tie-in bar out of the footing or it will create a buldge in your wall.
4. **TIP!** After the first row of ICF has been stacked your horizontal measurement can be written on the wall. All rebar for all necessary rows can be cut ahead of time for efficiency. Be sure to account for any window or doors in the wall.

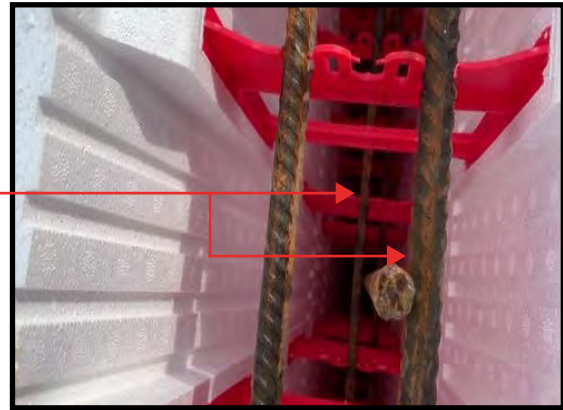

## Below Grade Rebar

Below grade rebar will go to the tension side of the wall. This is important!

Horizontal bar-Inside / middle always offset the horizontal rebar to hold the vertical bars in place.

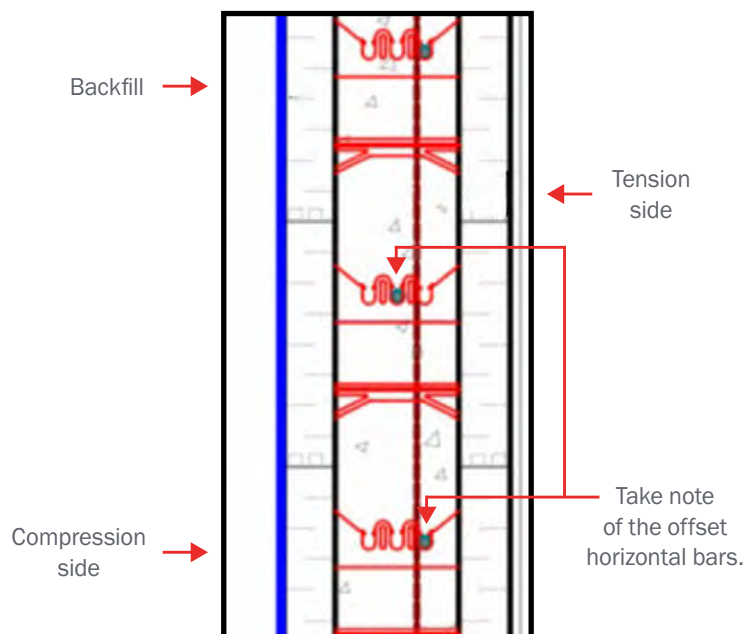

## Above Grade Rebar

Above grade rebar in the center of the wall as there is no tension side.

Horizontal bar-inside/outside

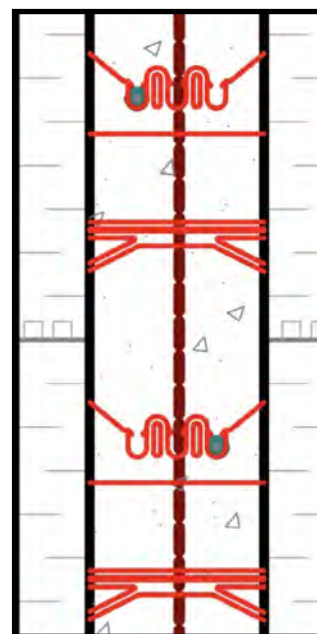

# Reinforcing Steel / Bar

## Vertical Rebar

Vertical rebar is always dropped in after all the block is stacked. This makes it a lot easier to stack the block. Vertical bar is typically placed beside a tie to hold it in place (pour concrete so the flow pushes the concrete against the web) however if needed it can be tied to the top horizontal bar. Care should be taken to make sure vertical rebar has enough concrete coverage at the top of the wall. 2" coverage is sufficient.

Rebar dowels continue up from the basement pour to continue on with main floor walls if ICF continues. Typically these are wetset in after the pour so they are not in the way for the concrete pour.

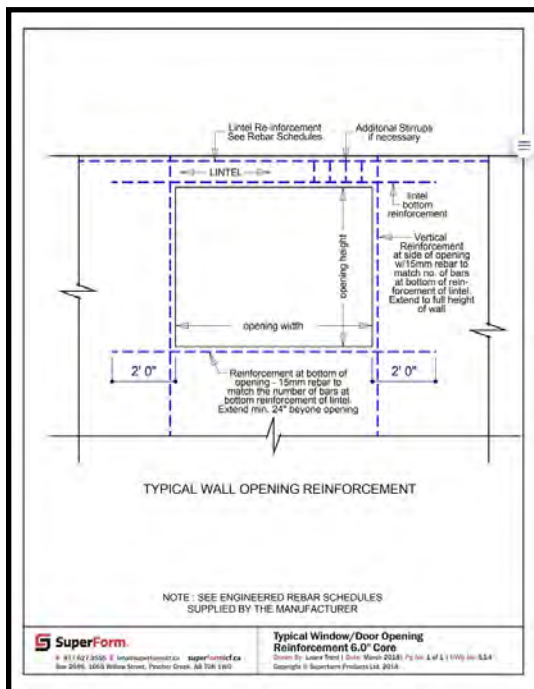

## Window/Door Reinforcing

**Lintels:** A lintel is a beam placed across openings like doors, windows, etc. in buildings to support the load from the structure above.

All lintel horizontal bars should extend 2' past openings. For sure 1 bar of steel should be placed within a few inches of the opening. Make sure it doesn't get pushed against the buck opening during concrete pour. Take note rebar stirrups may be required. Follow engineering, building codes and our lintel tables.

Refer to drawing 5.1.4 in reinforcement manual in the resource tab on our website.

**Typical stirrups used in ICF construction for lintels when necessary.**

These can be bent with a rebar bender on site or ordered through your dealer.

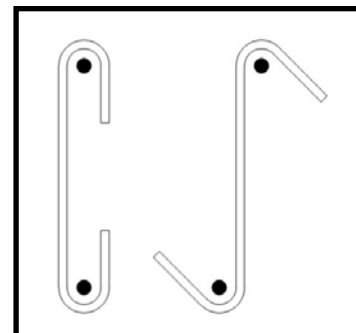

# Continuing Courses



Scan to watch the  
SuperForm ICF Video  
Continuing Courses

- ▶ The first 2 rows define the coursing layout for the rest of the rows.
- ▶ Alternating corner blocks provides the offset.
- ▶ All even courses lineup
- ▶ All odd courses lineup.
- ▶ Remember to install horizontal rebar as required as the courses go up.

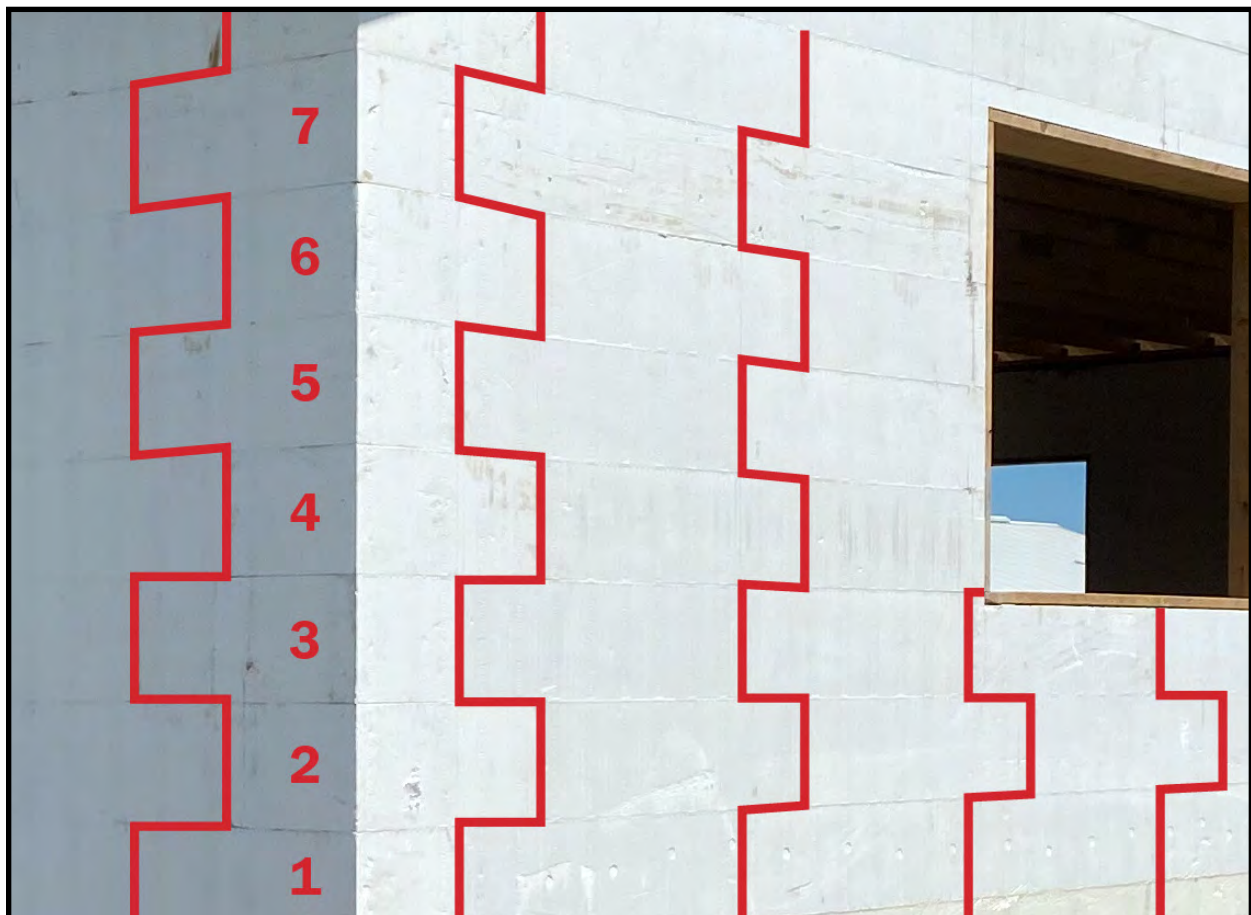

# Continuing Courses

1. Layout the location of the bracing system on the wall with a marker every 6'.
2. By the 5th row the ICF bracing will need to be installed.
3. When you are done for the day, make sure rebar is installed in your top row of ICF, ICF bracing is screwed to the wall, and all ground pins are secure. This ensures when you come back the next morning your wall will still be there.

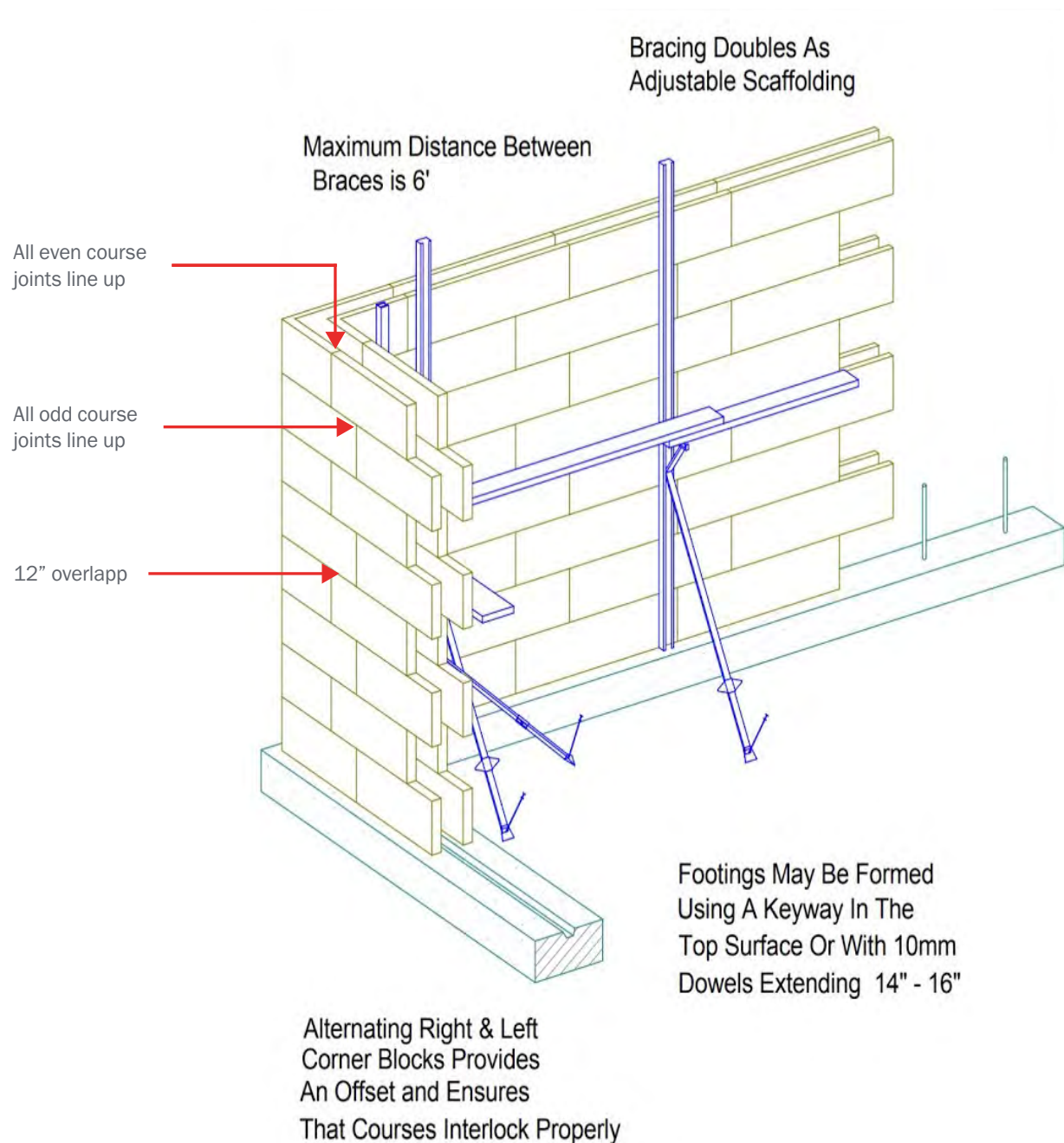



Scan to watch the  
SuperForm ICF Video  
Bracing & Scaffolding

# ICF Bracing / Scaffolding

Always follow bracing manufacturer safety standards and local safety protocol. A bracing set will include a vertical channel, a diagonal turnbuckle, scaffold plank support and handrail attachment if necessary.

## The bracing does 3 things

- ▶ It braces the wall from blowing over.
- ▶ It acts as a scaffold system to complete the ICF rows that can no longer be reached and to pour concrete (scaffold bracket).
- ▶ It straightens and levels the walls and keeps it aligned with its adjustable turn buckle



1. ICF bracing should start being erected by the 5th row. Layout the location of the aluminum channels starting from the a corner. If you are using **Hilltop bracing measure 24"one direction and 30" the other direction**. If you are using **Plumwall bracing measure 24" one direction and 42" the other direction** so the diagonal braces at the corner will not interfere with each other. Then layout the rest of the braces down the wall ideally every 6'.



2. Screw the aluminum channel to the wall through the tie. Screws should be installed in the **top of the slot and left slightly loose** for some settling during concrete pour and for straightening the wall.



# ICF Bracing / Scaffolding

3. Attach the diagonal to the aluminum channel using manufacturer approved connection



4. A steel stake/bent rebar or a couple screws can be put through the foot of the brace to secure it.

**IMPORTANT** - make sure the turn buckle threads are halfway before securing the foot so you can easily push it out or pull it in without running out of thread.

**VERY IMPORTANT** - be sure to insert a nail through the steel stake so the brace foot can not work itself up over the pin.



5. Install the scaffold bracket.  
It typically drops in over the Diagonal.

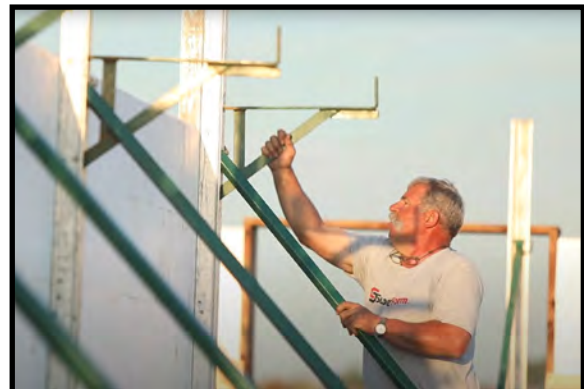

6. Install scaffold planks.  
This can be done by using 2x6 footing material or 2x12 planks



# ICF Bracing / Scaffolding

---

7. Install handrails if required.



\*Some systems may come as an all in one system but all ICF scaffold systems work in a similar fashion.

Your ready to go to work on the scaffold! Typically one man on the ground will be handing one man on the scaffolding blocks and materials for sake of efficiency and safety.



---

## Tall wall examples:

Here are a couple pictures of tall wall scaffolding. In the left hand picture a heavy duty scaffold system with guard rail was used. In the right hand picture blocks were stacked and concrete pour was completed on scissor lifts on the outside of the wall with bracing on the inside.







Scan to watch the  
SuperForm ICF Video  
Windows & Door Openings

# Window and Door Bucks

Window and door bucks provide a means in which to create an opening where a door or window may be installed. Window bucks can be built with numerous different materials however one of the most common methods is still wood.

## Building Bucks

1. Door bucks should be laid before you start stacking first row.
  2. Ensure you have the correct RO's from the manufacturer.
  3. Make sure your door bucks account for the floor thickness!
  4. Run the taught piece of your buck over the side pieces.  
This helps handle the weight of the concrete.
  5. When building window bucks run 2x4s for the sill at the bottom for room to fill with concrete and vibrate confirming sufficient consolidation. Have some 16" plywood ready to attach to sill to prevent concrete from continuously bubbling up.
  6. Nails or screws should be put through the wood buck into the concrete void before the pour to hold the buck securely in place afterwards.
  7. Wood bucks should be PWF or wrapped with poly if they are in contact with concrete. They should be attached to the SuperForm ICF using additional support. **See page 50.**
- **Efficiency Tip** - Bucks can be prebuilt by a crew in the shop or onsite with internal bracing so they are ready to go when needed.



1. Openings need to be braced internally approximately every **2 - 2.5'** to keep bucks straight because of the weight and pressure of concrete. These can be removed after the concrete has sufficiently cured.
2. Run a long 1x4 or 2x4 or 2x along the top of the opening if possible.
3. Window bucks are held in place with additional support/cleats both inside and outside. **See page 50.**



# Window and Door Bucks

---

1. Blocks may need to be cut horizontally above or below openings, a skill saw works good for this.

- ▶ For sake of efficiency always try to only cut blocks either on the top or bottom of your opening. If you cut the bottom row of ICF, the top row should run over the window buck. If you cut the block above the window buck, the buck should sit on the 4th/5th row etc.



- ▶ **TIP!** Order the right size of windows, so no blocks need to be cut horizontally. This is an option to maximize efficiency.
- ▶ **TIP!** In between windows is a great place to use cutoff pieces. Any cut off block 6" long can easily be used in the wall. Right below the top course is another great option as the pressure is the least at the top of the wall. A 6" overlap to get rid of waste is acceptable especially close to the top of the wall. A good installer will leave a jobsite with only a garbage bag full of waste!!



## Installing Window / Door Bucks

1. Once window and door bucks are built and the ICF is ready, set your bucks in place. It is easier to do this sooner than later.
2. Glue and tape the bottoms of your window buck down to the ICF. 2 to 3 strands of tape are sufficient.



Information on supporting window and door bucks with additional support can be found on page 50.

# Window and Door Bucks

Here is a few options to prevent thermal bridging through the buck if that is a concern.

---

## Half Buck

The half buck is great for fastening interior trim to take out in this practise. The inside EPS panel is cut 1.5" bigger all the way around the opening and butted into the exterior foam panel. Cut 2.5" off of the buck from the overall block thickness and use devil washers and 4" screws to attach it through exterior foam.

Pictures from the outside



Pictures from the inside



---

## Inserted Buck

The inserted buck is inset inbetween the EPS panels and the buck is flush with the foam. The EPS on the inside and outside is the actual R0. Attach 2x4s blocks to the sill the to hold the window buck in place. Devil washers with 4" screws are used to secure the buck to the foam. Internal brace as normal.

**Both options are easier to apply exterior stucco.**



# T Walls

T walls are quite common in foundations especially going from the basement into the garage etc. SuperForm T blocks make this very easy to accomplish.

1. Cut every other T- block 12" off to maintain 12" overlap.
  2. Bracing the T intersection is very important to maintain straight walls during the concrete pour. The concrete pressure will cause the T to bow out if it is not supported. **See page 49.**
- ▶ **TIP!** The 12" pieces can be used as filler pieces by windows etc.

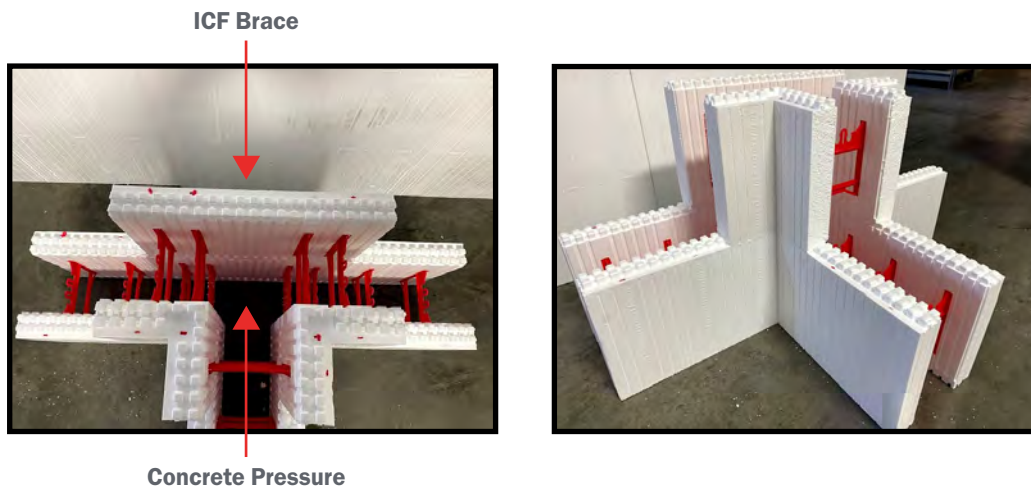

# 3" Height Adjuster

- ▶ 3" height adjusters work good if you need to get an extra 3" of height on your wall. Or they may work well to put above or below a window instead of cutting blocks.
1. Foam the 3" height adjuster both at the bottom as you put them down and on top as they set the final row of ICF down. Always place them as high in the wall as possible, installing them just below **the top row**.

Refer to drawing 7.1.1

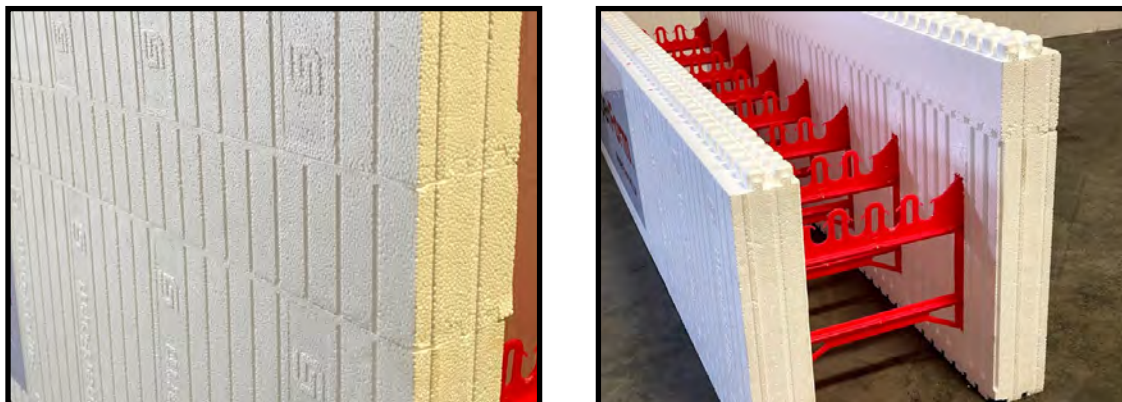

# Gable Walls

The construction of gable walls can be efficiently accomplished on slopes up to 12/12. Most gable walls are assembled and poured on top of previously poured walls of normal height. The rigidity of the solid wall below provides excellent alignment for the peaked wall above.

1. Start stacking blocks and have a general idea of the slope of your gable wall. Every row can be set back as far as possible to limit the amount of waste.



2. Set each row back as far as possible to minimize waste and accommodate slope

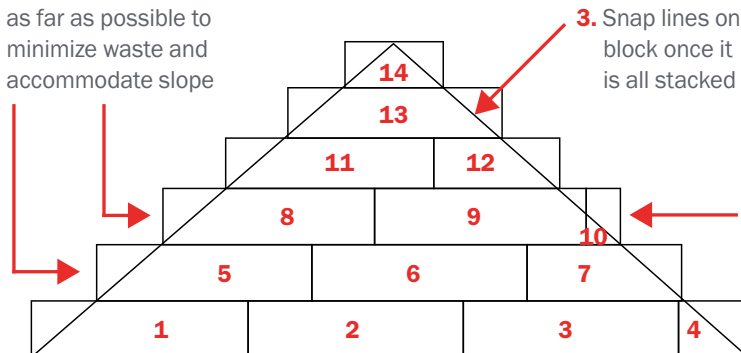

3. Snap lines on block once it is all stacked

4. Number each block to know where it goes when stacking

5. Use vertical bracing as normal. Once you have reached the peak of your gable you can snap lines on either side of the wall and both sides of the slope.
6. Use a skill saw to cut as far as you can and then use a reciprocating saw with an 8" blade to continue through. Do this on both sides of the wall.

A wood cap will have to be set on the slope to prevent concrete from slumping out. Attach the cap to the ICF with additional support. Holes can be cut into it every 48" or so to drop the pump hose into the wall. This wood cap can also have anchor bolts set into it and left on to use as a sill plate. Make sure you have done your gable calculations for height and slope correctly and this will be a sturdy gable wall to start bracing your roof system from.





Scan to watch the  
SuperForm ICF Video  
Top Row ICF

# Top Row ICF

The top row has a tendency to lift during the concrete pour. Here are a few options to prevent this.

---

## Taped

Taped every block vertically and horizontally with 2 pieces of tape around 12' long. Put a lot of pressure into the tape when applying it. this works very well and is the method we recommend to use. It is very cheap to do and minimal labour is required. The ICF bracing needs to be a max of 6' apart.



## 2x6

Attached a 2x6 around the perimeter of the wall, flush to the top. Put a 3" ICF screw into the 2nd tie from every block joint. This solidifies all blocks by creating one complete unit, not letting it lift. It also minimizes budging and keeps walls straight. It is labour intensive and you need straight lumber for this to work well.



## Spray Foamed

Foam each block down by applying a few squirts under each side and also foam the vertical joint. This glues each block together keeping it straight and rigid. It can be more pricy due to the cost of spray foam.



## Wire Clipped

Install 2 clips on every block. This is fast to install and works very well. But can be very pricy.



# Top Row ICF

Run string lines to make sure your wall is straight. The string line is typically run on the opposite side of bracing. Use the stringline to adjust walls before and after pour. **Before placing concrete ensure the walls are slightly tilted in. It's a lot easier to push the wall out then pull it in with the weight of the concrete in it.**

- ▶ Sink the top plate into the ICF is a great way to prevent thermal bridging. This should be lasered in for accuracy.
- ▶ Put a 2x6 on a piece of plywood to create a trowel that drops the level of the concrete at the pour to accommodate this.

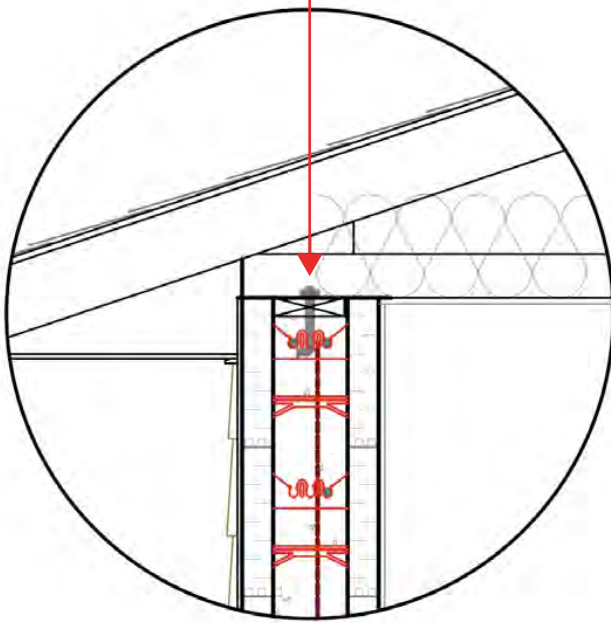



Scan to watch the  
SuperForm ICF Video  
Additional Support

## Additional Support

Superform is known for its very strong block and corners. If blocks are not cut no additional support is needed. However blocks often need to be cut for openings, filler blocks etc. At times additional form support will be needed to prevent blowouts and issues.

When in doubt, always over brace. You will never know when you over brace, but will always know when you under brace.

### Stacked Joints

- ▶ Stacked joints needed to be supported on every row, inside and outside of wall.



### Inadequate Overlap

- ▶ When the overlap is less than 8" on 2 rows, additional will be needed. **Overlap 8" or over is good, overlap 7" or under is not.** If this overlap is close to a opening, corner, or any intersection, all rows will need additional supported. See corner section in this chapter.

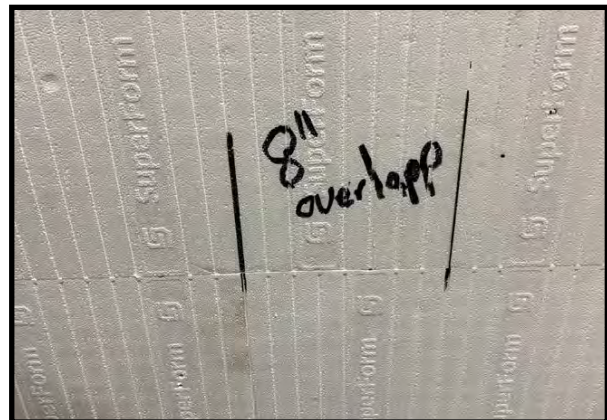



# Additional Support

---

## Corners

- ▶ All joints/overlaps by corners should be 12", making your filler block in the middle of the wall. This leave adequate overlap strength for concrete pressure.
- ▶ If walls are 8' tall or under. No additional support is needed if overlap is 12" on corner joints.
- ▶ If walls are 9' tall or over, overlap additional support is needed on the bottom 3 rows on the short leg of the corner.
- ▶ If walls are 10' tall or over, a corner L bracket on the bottom row. This helps solidify the bottom block where the concrete pressure is. Overlap additional support is needed on the next 3 rows on the short leg of the corner.
- ▶ If there is a 3' or under jog in the wall, you will need additional support on every row, inside and outside of wall.



---

## T-Block

- ▶ T blocks always need additional support due to the extended amount of foam with no Tie. 3' piece of additional support should be added to each row. This should be a sturdy piece that will not flex.
- ▶ If pour is 8' or under, not more is needed. If wall is 9' or over, a ICF brace must be applied over the additional support braced back on the top and bottom.
- ▶ Overlap should always be 12" by a T. If it is under 12", overlap additional support is needed as well.



# Additional Support

---

## Openings

- ▶ If an opening is under 4' from a corner the buck should be tied back with strapping to the corner to keep it straight due to the concrete pressure.
- ▶ 1 screw in the cleat and 1 in the buck. If this is not done the pressure from the concrete will separate the ICF and buck. By putting 1 screw into the ICF tie and 1 screw into the buck it allows for any settling of the ICF while the door buck doesn't settle. Be aware of some block settling that may occur especially in our 6.5" block series. Leave a gap between the window, buck and the block on top of the opening to accommodate this.



- ▶ We recommend added additional support to every row of block on all openings. This keeps bucks straight and plumb and holds them in place so they will not move during the concrete pour.



# Additional Support

---

## 45 Degree

1. 45 degree block should be braced just like corner blocks.

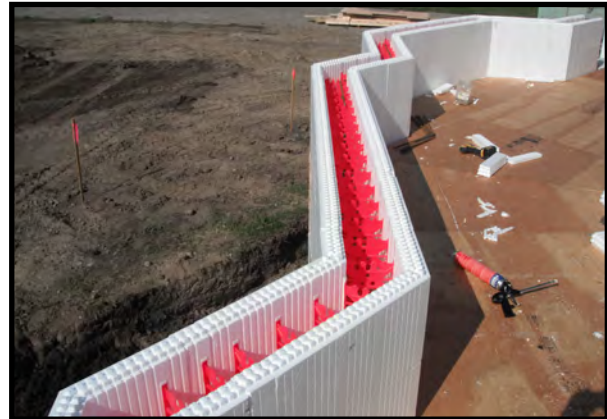

## Compromised Blocks

- ▶ If 4 bars of foam(4") extends a tie and terminates, additional support is needed. The 4 bars will bow or break out if not supported.
- ▶ If 3 bars of foam(3") are beside an opening, that needs to be additionally supported. 3 bars of foam(3") in a wall will be ok.
- ▶ Whenever a tie is cut for any reason ( i.e.: 6" sleeve for utilities), additional support will be needed to make up for the tie strength on both sides.

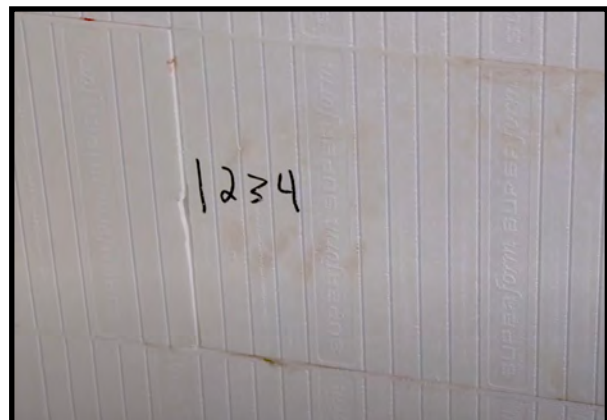

## Lack of Additional Support

- ▶ This is what happens when additional support is not used, but is needed to keep the joint solid. Areas that need additional support will move during the concrete pour if they do not get the additional support they need.





Scan to watch the  
SuperForm ICF Video  
Wall Penetrations

# Wall Penetrations

Wall penetrations will need to be placed in strategic locations when ICF is going past the floor system and up into the main floor walls. Consideration to where floor trusses are located along with consulting the mechanical contractor are all important considerations so they don't conflict. In ICF basement only applications this isn't as critical as the mechanical penetrations are cut in after the floor is on typically. However there still may be a few penetrations needed.

1. Before the concrete pour check in with your electrician and plumber and any other sub trades that may need to run utilities through the wall. Putting these in beforehand is a lot less labour intensive then drilling a hole through concrete later.



2. Use a reciprocating saw or a hole saw to cut the hole.
3. Draw a circle around the hole and proceed.
4. Insert sleeve through ICF wall.
5. Use spray foam to fill any cracks bigger than 1/4" around wall penetrations so it doesn't move during the concrete pour or to let concrete out



## Checklist for Wall Penetrations

### Electrical

- ▶ Incoming wire
- ▶ Exterior outlets
- ▶ Exterior light fixtures
- ▶ Phone/cable line

### Plumbing

- ▶ Septic line
- ▶ Hose bibs
- ▶ Water line
- ▶ Incoming water line

### HVAC

- ▶ Dryer vent
- ▶ Wall range hood vents
- ▶ Air conditioning lines
- ▶ Furnace vent

# Vertical Cold Joints

---

- ▶ Vertical cold joints are only installed in special situations where necessary, often large jobs with multiple pours. Typically lumber is used as a buck and then taken off before the next pour and rebar is installed per specification.





Scan to watch the SuperForm ICF Video Floor Connections

# Floor Connections

Depending on the building plans and customer desires a couple different options are available to attach your floor to. It is very important to always check plans and make sure beam pockets and all framing/ floor requirements are in place and manufacturers floor connections manuals are followed.

## Beam Pockets

Beam pockets may be necessary for porch, roof, or deck beams. Always check your plans. Our foam bucks work well for this or wood can be used to block out for a beam to sit in later.



## Simpson Strong Tie ICFVL

1. If you are continuing on with ICF this is a great option. Put the ICFVL through the foam into the concrete void before the pour. Spacing of this ICFVL is per manufacturer's tables. Also see drawing 7.2.1 and drawing 7.2.2 in our technical drawings.

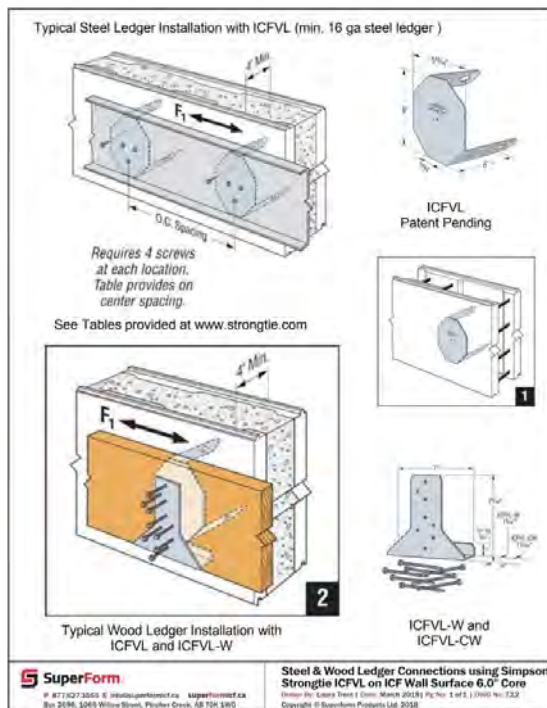

See website for more videos and manuals.

# Floor Connections

## Anchor Bolted Ledger

A 4" hole needs to be cut out of the foam to make this option work. **Sufficient concrete must encapsulate the anchor bolt.** The ledger board can be permanently screwed (the screws are not structural they only hold the ledger board on strait and keep concrete from coming out) on with anchor bolts at the required locations, however often the vertical bracing is in the way of accomplishing this so some planning must be involved. See drawing 7.1.1 and 7.1.2 in our technical manual.

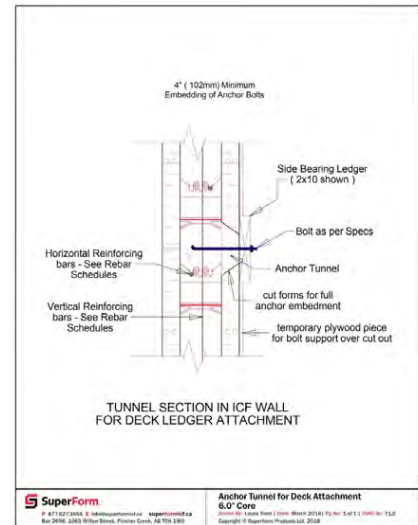

## Concrete Floor

The exterior ICF panel should continue through with the interior one being cut off the thickness of the floor. There are numerous types of concrete floor systems. All systems must bear on the concrete.

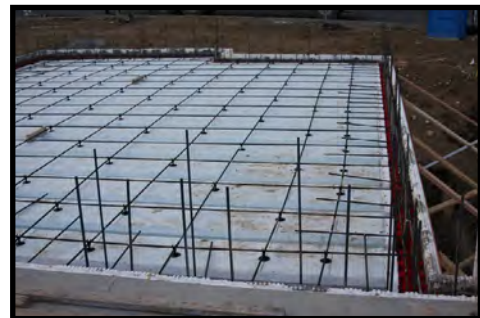

For ICF not continuing on anchor bolt are placed in level concrete. A sill plate will be installed and trusses will be attached.



# Prepour Inspection



Scan to watch the  
SuperForm ICF Video  
Concrete Pour

Pre pour inspections are very important. They ensure you are 100% ready for concrete. If you are in doubt add additional support.

- Quick visual check to confirm block is still on the chalk line.
- All walls are level and plumb.
- Wall dimensions are correct.
- String line is ready to straighten top of wall.
- All joints, windows, and doors are additionally supported if necessary.
- Anchor bolts are ready if needed.
- Short wall sections are strapped.
- Beam pockets are in place.
- Floor embedments are in place.
- Concrete placing equipment is ready.
- Bracing/ICF wall is leaning slightly inward for concrete.
- Concrete placement plan with crew.
- Openings are braced and framed.
- Spray foam can be used to fill any gaps that are left. Any gap bigger than 1/4" should be spray foamed.
- If you are going up with a second level of SuperForm cover all knobs with the 4" SuperForm Tape. 4" tapes keep everything clean and tidy for the next level.
- If this is your last pour of ICF, SuperForm recommends trimming off all knobs.
- Vertical rebar is extended through the pour or pieces are cut to wetset in if ICF is continuing.





# Concrete Pour

The Concrete mix design must meet engineered spec and/or conform to national and local code jurisdiction. The concrete slump should be 5"-6". Judge the slump by the angle in which it flows. Have a concrete pour plan confirmed with the pump operator and your crew. If possible have at least a 3-4 man crew.

1. The most common method of pouring concrete into ICF is with a concrete pump truck however a crane and bucket and the chute off the concrete truck are options.
2. According to ACI 318 and building codes, pour concrete in 4' lifts. Pouring in 4' lifts will allow entrapped air to rise to the surface.
3. Go around the first time and fill beneath the windows and make sure there are no voids beneath them.



4. Consolidation is the removal of entrapped air in the concrete. Because the EPS does not come off you need to be sure that there are no voids in the wall. Consolidation ensures that the rebar is properly embedded in the concrete.
5. Use a vibrator - 1" head max. (cordless vibrator works great)
6. Insert it quickly into the depth of the concrete lift. Pull it slowly out.
7. Use a hammer to tap window bucks along with a vibrator to consolidate concrete below the window.
8. Do not place concrete directly into corner forms. Stay 2-3 feet back and let it flow through.
9. Max concrete pour height is 12'



# Concrete Pour

---

1. If ICF wall is not continuing on make sure concrete is level and anchor bolts have been wetset into the concrete. A laser level will get near perfect elevation making the sub trades coming behind very satisfied with ICF walls.



2. If the wall is continuing on with ICF make sure rebar is coming through as per specifications and concrete is a couple inches down from the top of the form.
3. Always check for door openings. Do not install rebar where a door is located and trowel the concrete flush making it convenient to run the sub floor directly over the door openings.



# Post Pour Concrete Checklist

---

- All areas are consolidated
- Ensure all embedments are in place and haven't moved.
- Walls are straight, plumb and level. Limit scaffold activity after this.
- Double check that walls are straight, plumb and level.
- Bucks for openings have not moved.
- Service penetrations have not moved.
- Concrete is protected on top from freezing if needed.
- Anchor bolts are in or rebar is in for continuing ICF.
- Beam pockets are in place for any beams needed for framing etc.
- 4" SuperForm tape is removed



# Continuing on with ICF / Next Level

For ease of work, safety and efficiency the floor should be installed for working on your next ICF level if there is a floor. Either a subcontractor will come in and do it or it could be your job.

1. A ledger system will have been determined before the pour.  
The cross ties are not meant to support structural loads.
2. If you are using the Simpson Strong-tie ICFVL, the ICFVL-CW/W will be installed at this time.

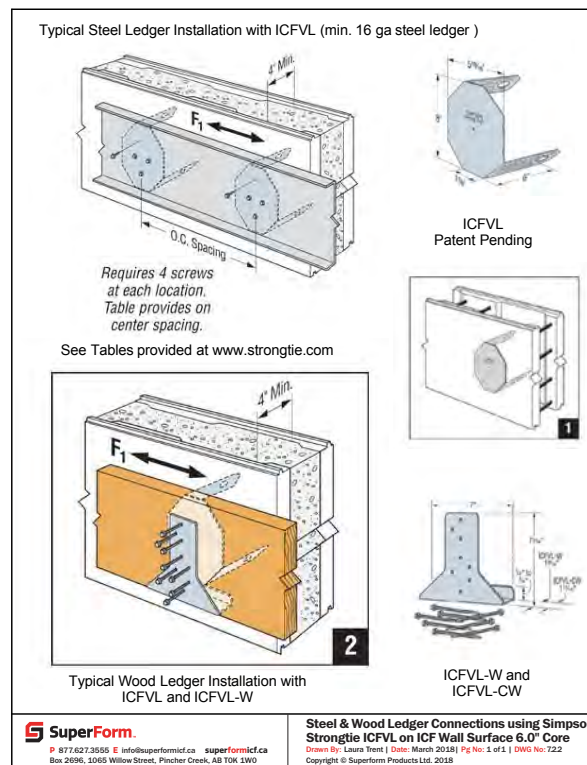

# Continuing on with ICF / Next Level

1. Use all the same practise we outlined regarding ICF all over again. Stack, brace, pour, repeat.

► **TIP!** If you use the 4" SuperForm Tape the knobs will be clean and ready for you to continue stacking.

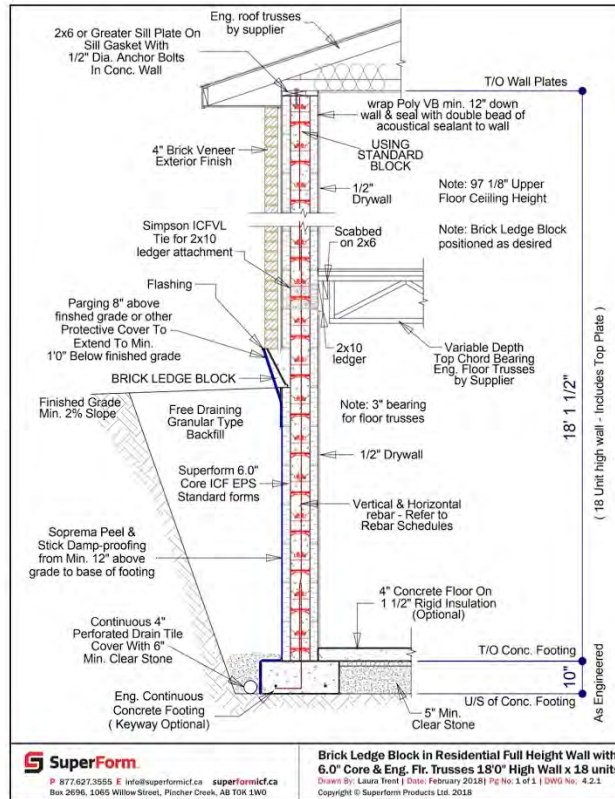

# Waterproofing / Dampproofing

Keeping water out of your below grade wall cannot be overemphasized and must be used below grade. Waterproofing must be compatible with EPS. Below are a few options.

---

1. Soprema is a high-quality, self-adhesive, rubberized peel and stick sheet designed for dampproofing SuperForm ICF construction. Benefits include high tensile strength and puncture resistance, greater flexibility and consistent thickness, ensuring the high-end waterproofing required to give you peace of mind that your below-grade builds won't leak.



2. Dimple Wrap. A permanent moisture barrier that prevents the exterior backfill from touching the foundation wall. Dimple wrap also provides an air gap allowing the foundation to breath and transmit moisture to the footing drainage. It is fastened with special fasteners through the raised dimples.



3. Liquid spray on or roll tar is acceptable if it is EPS compatible.



# Installing Soprema

Installation guidelines as per Soprema.ca guidelines. Typically you will need at least 2 people to install the peel and stick and it usually works best installed vertically. **It is extremely important to follow manufacturer's instructions to receive warranty if product fails.**

1. Cover all small projections (pipes, etc.) with a detailed membrane and seal the ends. Make sure EPS is clean.
2. All interior and exterior angles and the footing at the corner must first be covered with a 300 mm (12 in) wide strip of detail membrane centered on the corner. This strip must be applied directly on the surface, with no gaps between the surface and the membrane. Outside corners should be double lapped. On a clean, dry surface, COLPHENE ICF membrane does not usually require primer. Use water-based ELASTOCOL STICK H2O primer when the surface is really dirty; solvent-based primers could damage the polystyrene and must not be used.
3. Install the membrane vertically by gradually removing the silicon paper while pressing on the membrane to promote bonding.
4. Continue to install the COLPHENE ICF membrane on the entire foundation wall, making sure it is aligned with the previous roll. Longitudinal overlaps must measure at least 75 mm (3 in.), while transversal overlaps must be at least 150 mm (6 in.) Use the dotted lines on the Soprema for guidance.
5. Apply uniform pressure over the entire protective membrane **using a roller**.
6. Tears and holes must be repaired using the appropriate membrane. The patch must be at least 100 mm (4 in.) larger than the affected surface. The edges of the patch will be sealed with waterproofing mastic.
7. Apply a bead of soprasteel on the top termination of the membrane to keep it from peeling down.
8. Any waterproofing membrane that can be seen after filling must be protected from UV rays and mechanical damage.

## More Tips

- ▶ Make sure the waterproofing wraps around the footing and comes down the vertical wall of the footing.
- ▶ Soprema can be precut for efficiency once desired length is attained.
- ▶ Once the back wrapper is off be very careful not to let the soprema stick together as it's almost impossible to pull apart once it does. For this reason Soprema should be applied to the ICF and the brown backer paper should be pulled off simultaneously.

If specified a combination of both can be used soprema and dimple board can be used.



For full detailed instructions visit our website

# Backfilling

Take care when backfilling and make sure that the damp proofing/waterproofing is not punctured. Backfill should be free of sharp rocks and debris.

---

1. All walls should be laterally supported at the top with a floor system before backfilling.



2. A perimeter drainage system is always required on all below grade projects.

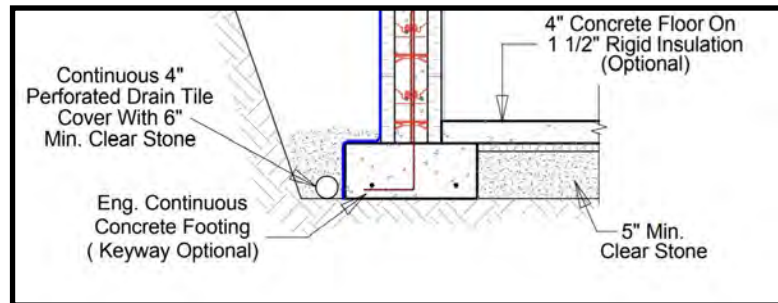

3. If backfilling and compacting is happening on both sides of the wall make sure to bring both sides up at the same time to maintain equal pressure.





# Brick / Stone

1. The Ledge Block is designed to provide a ledge base to stack brick or stone. The ledge portion of this block is intended to be tied back into the main wall by means of a minimum of  $\frac{1}{4}$ " reinforced steel stirrup that is bent to hook over the horizontal rebar in the wall and the rebar in the front portion of the ledge. The horizontal rebar in the wall must be placed in the rear-most slot, opposite the ledge, and both this steel and the horizontal steel in the front of the ledge must be a minimum of  $\frac{1}{2}$ " (10mm). When stirrups are placed in every other space in the ledge block (12" on center) and a minimum of 2500 psi strength concrete is poured and allowed to cure sufficiently, this ledge has been designed to carry 1,000 pounds per lineal foot. Stirrups placed in every spaced in the ledge block (6" on center) and a minimum of 2500 psi strength concrete is poured and allowed to cure sufficiently, this ledge can carry 2,000 pounds per lineal foot. All calculations assume that brick or stone is tied back to the wall with metal ties as per local codes, and does not protrude past the outer edge of the concrete ledge by more than one inch, or  $\frac{1}{4}$ " of the bricks depth, whichever is less. Higher weight calculations may be arrived at by increasing diameter of the stirrups and by local engineering design of heavier wall reinforcing and stronger concrete.

Refer to drawing 5.1.2 in technical manual for more details

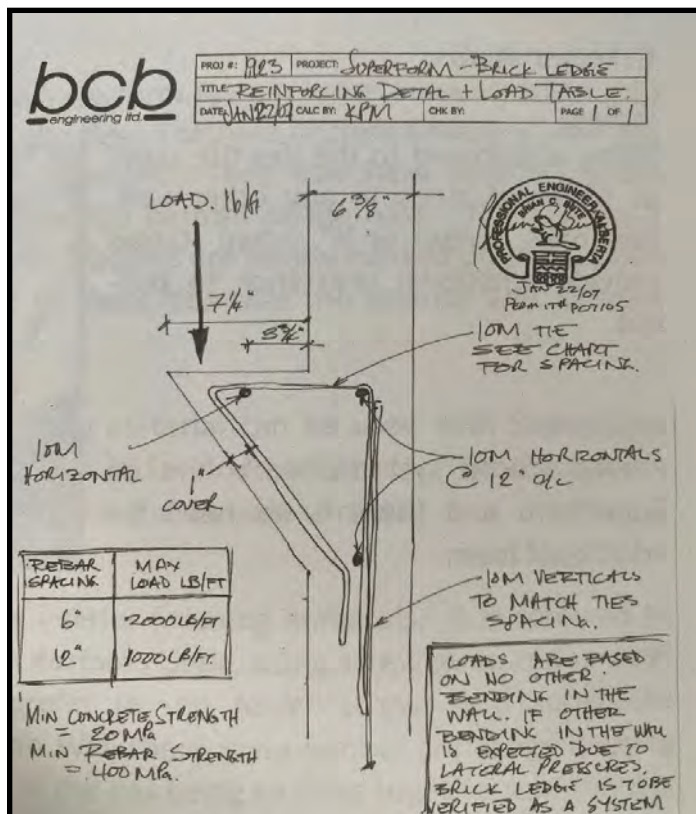

# Parging

---

1. Generally, parging consists of a cement based grout that is troweled over a type of wire mesh or metal lath, much like stucco. This “mesh” extends from the underside of a metal flashing at the bottom of the wall’s exterior finish. It is applied over the dampproofing layer and below the exterior grade approximately 12". Conventional concrete type parging and acrylic type cement parging work equally well. As in dampproofing there are several ways to finish the exposed portion of a SuperForm wall, (the portion that is above the finished ground elevation but below the exterior wall finish). This buffer accomplishes more than one task at the same time. The parging provides a separation between grass, gravel and other ground level materials. Parging protects from moisture, insects and other undesirable elements that may be present. It also provides the start to the walls exterior finish. Parging provides a means of covering the exposed EPS, protecting it from sunlight, impacts and scuffs from lawn mowers, weed trimmers, etc. It also acts as a protector for the damp-proofing material; protecting it from the same hazards previously mentioned.



---

## Commercial Finish

2. Run a strip of PWF plywood approximately 1' wide. This will work as a good starting point for your exterior finish.



# Electrical Installation

---

1. Electrical rough-in is straightforward in SuperForm.
2. After the concrete has been placed electrical chases and boxes can be cut into the EPS foam using a router, chainsaw with a guard or a hot groover. The boxes are mounted to the tie. SuperForms ties are triangular at the top and bottom of the block for ease of cutting to run wires while also preventing settling.
3. Sleeves should have been installed for through wall services before the pour.
4. Make sure the chase is  $1\frac{1}{4}$ " into the foam to prevent a drywall screw from hitting it.

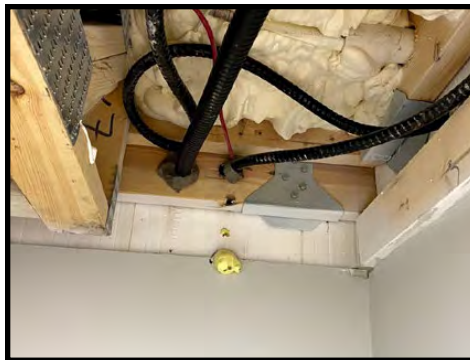
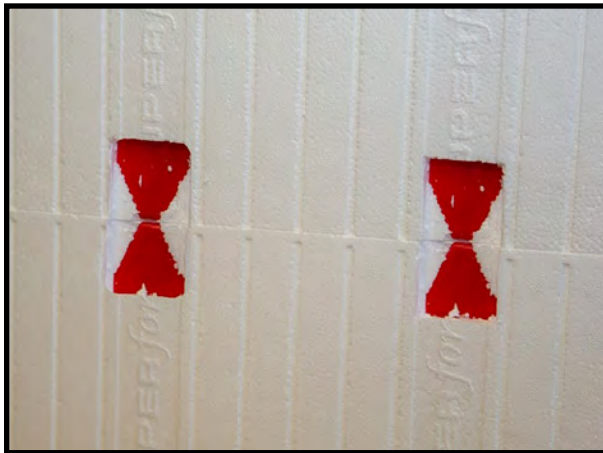

# Plumbing Installation

---

The EPS is thick enough for a 2" I.D pipe to be recessed and fit flush with the face of the wall. Keep in mind some codes will not let you run plumbing in the EPS of the foam. Preplanning of stacks etc. for running in interior walls at the early stages of house plans with your home designer as with the plumber is critical.

All sleeves should have been properly installed in the right location before the pour in wall penetrations earlier.



# Interior Finishes

1. Anything can be applied to the interior of SuperForm ICF however the most typical application is drywall. Often drywall needs to be applied to cover the EPS for fire rating specifications.



2. Drywall can be perimeter screwed and interior glued. Be sure to use glue that is compatible with EPS.

Refer to drawing 5.4.7 for info on wood walls butting into ICF.

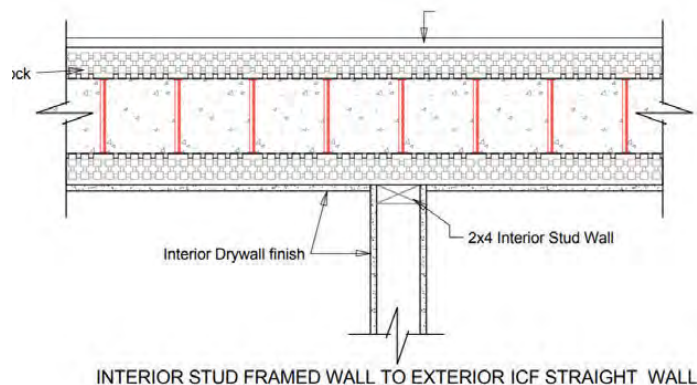

# Exterior Finishes

Any type of exterior finish is suitable for use in ICF construction. Typically screws or ring nails should be used to attach the majority of exterior finishes.

---

1. It is important to note that no weather resistant barrier is required over ICF. Flashing is necessary over door and window openings.



2. Some prep work will be required over SuperForm ICF for Acrylic stucco. Hard coat stucco with wire lath can also be fastened to the block.



3. When installing some exterior coverings the contractor may choose to strap the building. However with a little bit of strategic planning you do not need to strap it.
  - ▶ Do not pre drill metal siding if you do not strap it. Only pre mark it and pay close attention to the ties.











# Prepour Inspection



Scan to watch the  
SuperForm ICF Video  
Concrete Pour

Pre pour inspections are very important. They ensure you are 100% ready for concrete. If you are in doubt add additional support.

- Quick visual check to confirm block is still on the chalk line.
- All walls are level and plumb.
- Wall dimensions are correct.
- String line is ready to straighten top of wall.
- All joints, windows, and doors are additionally supported if necessary.
- Anchor bolts are ready if needed.
- Short wall sections are strapped.
- Beam pockets are in place.
- Floor embedments are in place.
- Concrete placing equipment is ready.
- Bracing/ICF wall is leaning slightly inward for concrete.
- Concrete placement plan with crew.
- Openings are braced and framed.
- Spray foam can be used to fill any gaps that are left. Any gap bigger than 1/4" should be spray foamed.
- If you are going up with a second level of SuperForm cover all knobs with the 4" SuperForm Tape. 4" tapes keep everything clean and tidy for the next level.
- If this is your last pour of ICF, SuperForm recommends trimming off all knobs.
- Vertical rebar is extended through the pour or pieces are cut to wetset in if ICF is continuing.



# Post Pour Concrete Checklist

---

- All areas are consolidated
- Ensure all embedments are in place and haven't moved.
- Walls are straight, plumb and level. Limit scaffold activity after this.
- Double check that walls are straight, plumb and level.
- Bucks for openings have not moved.
- Service penetrations have not moved.
- Concrete is protected on top from freezing if needed.
- Anchor bolts are in or rebar is in for continuing ICF.
- Beam pockets are in place for any beams needed for framing etc.
- 4" SuperForm tape is removed





**T** 877.627.3555

**F** 403.627.3553

**E** info@superformicf.com

**superformicf.com**

**Follow Us On**



**YouTube**